

**TM 11-5805-387-10-2**

**OPERATOR'S MANUAL**

**EQUIPMENT  
DESCRIPTION  
PAGE 1-3**

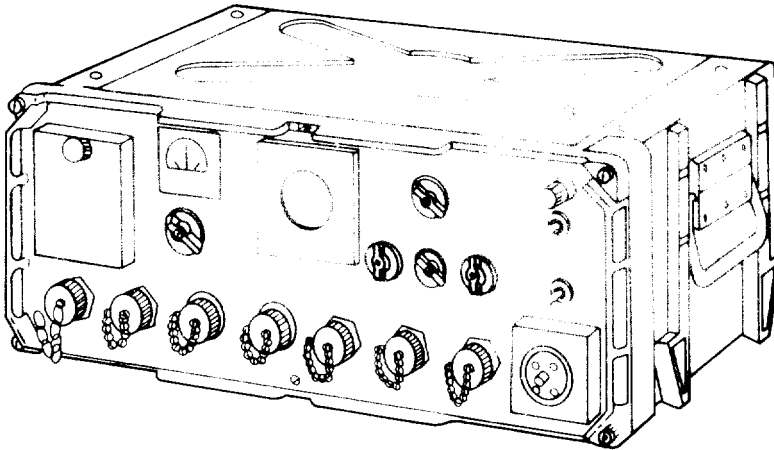

**OPERATOR'S  
CONTROLS  
PAGE 2-1**

**PREVENTIVE  
MAINTENANCE  
(PMCS)  
PAGE 2-8**

**MODEM  
RADIO TELETYPEWRITER**

**OPERATION  
PAGE 2-12**

**MD-522A/GRC  
(NSN 5815-00-919-4800)**

**TROUBLE-  
SHOOTING  
PAGE 3-1**

---

**HEADQUARTERS, DEPARTMENT OF THE ARMY**

5 APRIL 1984



TECHNICAL MANUAL

HEADQUARTERS  
DEPARTMENT OF THE ARMY

No. 11-5805-387-10-2

Washington, DC, 5 April 1984

OPERATOR'S MANUAL  
MODEM RADIO TELETYPEWRITER  
MD-522A/GRC  
(NSN 5815-00-919-4800)

**REPORTING ERRORS AND RECOMMENDING IMPROVEMENTS**

You can help improve this manual. If you find any mistakes or if you know of a way to improve the procedures, please let us know. Mail your letter, DA Form 2028 (Recommended Changes to Publications and Blank Forms), or DA Form 2028-2 located in back of this manual direct to: Commander, US Army Communications-Electronics Command and Fort Monmouth, ATTN: DRSEL-ME-MP, Fort Monmouth, New Jersey 07703. In either case, a reply will be furnished to you.

		PAGE
CHAPTER 1	INTRODUCTION . . . . .	1-1
Section I.	General Information . . . . .	1-1
	Scope . . . . .	1-1
	Consolidated Index of Army Publications and Blank Forms . . . . .	
	Maintenance Forms and Records. . . . .	1-1
	Destruction of Army Electronics Materiel Administrative Storage. . . . .	
	Reporting Equipment Improvement Recommendations (EIR). . . . .	1-2
	Nomenclature Cross-Reference List. . . . .	1-2
	List of Abbreviations . . . . .	1-2
II.	<span style="border: 1px solid black; padding: 2px;">Equipment Description . . . . .</span>	1-3
	Purpose, Capabilities, and Features. . . . .	1-3
	Description of the Modem . . . . .	1-3
	Performance Data . . . . .	1-4
	Weights and Dimensions . . . . .	1-4
III.	Technical Principles of Operation . . . . .	1-5

\*This manual supersedes so much of TM 11-5805-387-15-2, 6 June 1967, including all changes as pertains to operator's maintenance.

	PAGE
CHAPTER 2 OPERATING INSTRUCTIONS . . . . .	2-0
Section I. Description and Use of Operator's Controls, Indicators, and Connectors . . . . .	2-1
II. Preventive Maintenance Checks and Services (PMCS) . . . . .	2-8
PMCS Procedures . . . . .	2-11
III. Operation Under Usual Conditions . . . . .	2-12
Types of Operation . . . . .	2-12
Preparation for Use . . . . .	2-12
Operating Procedure . . . . .	2-13
IV. Operation under Unusual Conditions. . . . .	2-22
CHAPTER 3 MAINTENANCE INSTRUCTIONS. . . . .	3-0
Section I. Troubleshooting . . . . .	3-1
Circuit Breaker Check. . . . .	3-1
Troubleshooting Procedures . . . . .	3-1
II. Maintenance Procedures . . . . .	3-2
APPENDIX A REFERENCES . . . . .	A-1
B COMPONENTS OF END ITEM AND BASIC ISSUE ITEMS LISTS. . . . .	B-2
C ADDITIONAL AUTHORIZATION LIST (Nonapplicable) . . . . .	
D EXPENDABLE SUPPLIES AND MATERIALS LIST . . . . .	D-1
GLOSSARY . . . . .	G-1
INDEX . . . . .	I-1



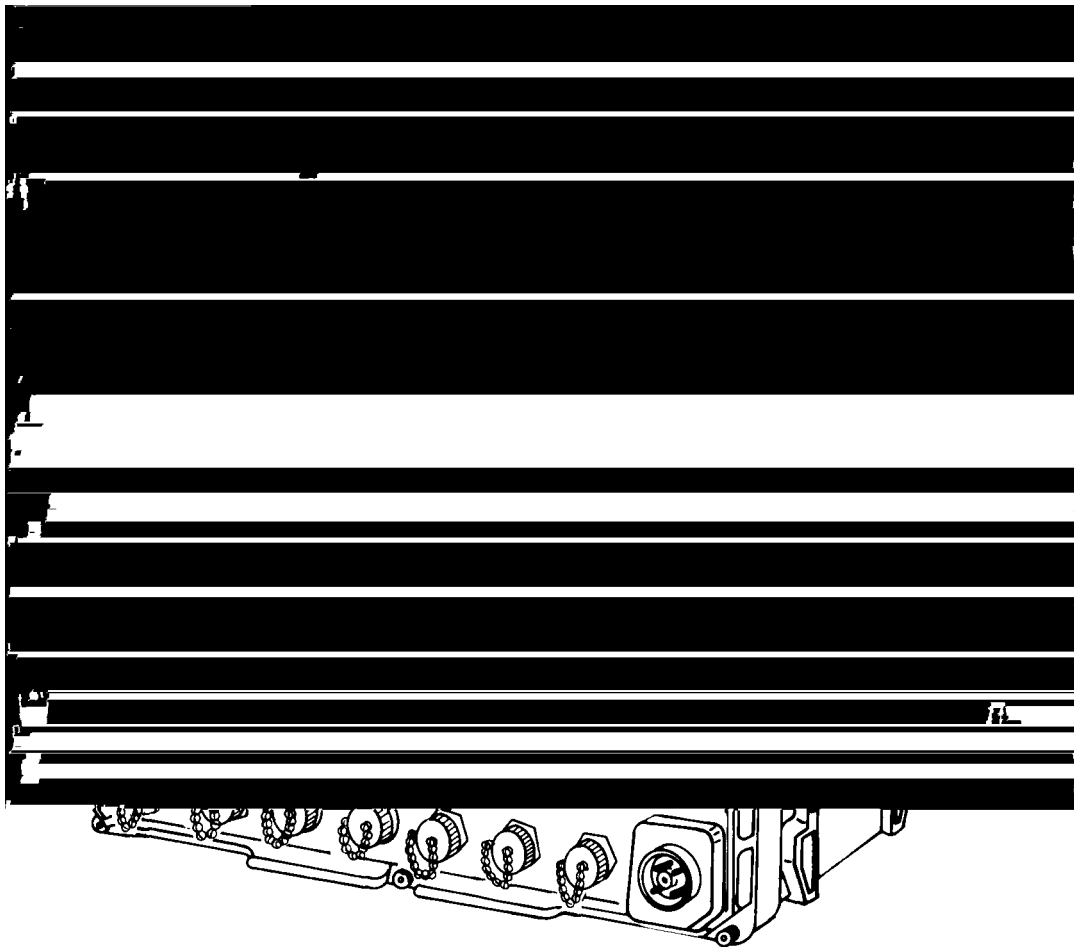

MODEM RADIO TELETYPEWRITER MD-522A/GRC

- 5 SAFETY STEPS TO FOLLOW IF SOMEONE IS THE VICTIM OF ELECTRICAL SHOCK**
- 1 DO NOT TRY TO PULL OR GRAB THE INDIVIDUAL**
- 2 IF POSSIBLE, TURN OFF THE ELECTRICAL POWER**
- 3 IF YOU CANNOT TURN OFF THE ELECTRICAL POWER, PULL, PUSH, OR LIFT THE PERSON TO SAFETY USING A WOODEN POLE OR A ROPE OR SOME OTHER INSULATING MATERIAL**
- 4 SEND FOR HELP AS SOON AS POSSIBLE**
- 5 AFTER THE INJURED PERSON IS FREE OF CONTACT WITH THE SOURCE OF ELECTRICAL SHOCK, MOVE THE PERSON A SHORT DISTANCE AWAY AND IMMEDIATELY START ARTIFICIAL RESUSCITATION**

WARNING

HIGH VOLTAGE

is used in the operation of this equipment

DEATH ON CONTACT

may result if personnel fail to observe safety precautions. Do not be misled by the term LOW VOLTAGE. Voltage as low as 50 volts may cause death under certain conditions.

DON'T TAKE CHANCES!

Be careful when working on this equipment. Serious injury or death may result from contact with terminals.

HIGH VOLTAGES EXIST IN THE FOLLOWING EQUIPMENT:

Scope module A2 . . . . .	1,100 vdc
Loop battery module A5 . . . . .	127 vdc
DC LOOP NO. 1 and DC LOOP NO. 2 connectors . . . . .	120 vdc
Various connectors and power supply components. . . . .	27 vdc

WARNING

Adequate ventilation should be provided while using TRICHLOROTRI-FLUOROETHANE. Prolonged breathing of vapor should be avoided. The solvent should not be used near heat or open flame, the products of decomposition are toxic and irritating. Since TRICHLOROTRIFLUOROETHANE dissolves natural oils, prolonged contact with skin should be avoided. When necessary use gloves which the solvent cannot penetrate. If the solvent is taken internally, consult a physician.

WARNING

Compressed air shall not be used for cleaning purposes except where reduced to less than 29 psi and then only with effective chip guarding and personnel protective equipment. Do not use compressed air to dry parts when TRI-CHLOROTRIFLUOROETHANE has been used. Compressed air is dangerous and can cause serious bodily harm if protective means or methods are not observed to prevent chip or particle (of whatever size) from being blown into the eyes or unbroken skin of the operator or other personnel.





RADIATION HAZARD



RADIOACTIVE MATERIAL  
 CONTROLLED DISPOSAL REQUIRED  
 ACCOUNTABILITY NOT REQUIRED

Meter . . . . . Ra 226 . . . . . 1.0uCi . . . . . 6625-00-257-1103

Radiation Hazard Information: The following radiation hazard information must be read and understood by all personnel operating or repairing Modem Radio Teletypewriter MD-522A/GRC. Hazardous radioactive materials are present in the above listed component of the MD-522A/GRC. The component is potentially hazardous when broken. See qualified medical personnel and the local Radiological Protection Officer (RPO) immediately if you are exposed to or cut by broken components. First aid instructions are contained in TB 43-0116, TB 43-0122, and AR 755-11.

NEVER place radioactive components in your pocket. Use extreme care NOT to break radioactive components while handling them.

NEVER remove radioactive components from cartons until you are ready to use them.

If any of these components are broken, notify the local RPO immediately.

The RPO will survey the immediate area for radiological contamination and will supervise the removal of broken components.

The above listed radioactive components will NOT be repaired or disassembled.

Disposal of broken, unserviceable, or unwanted radioactive components will be accomplished in accordance with the instructions in AR 755-15.



## CHAPTER 1 INTRODUCTION

### Section I. GENERAL INFORMATION

#### 1-1. SCOPE

This manual is for your use in operating the Modem Radio Teletypewriter MD-522A/GRC. It gives detailed operating instructions, and will tell you how to maintain the equipment.

Additional information about the MD-522A/GRC may be found in the manual for the specific radio teletypewriter with which it is used.

#### 1-2. CONSOLIDATED INDEX OF ARMY PUBLICATIONS AND BLANK FORMS

Refer to the latest issue of DA Pam 310-1 to determine whether there are new editions, changes or additional publications pertaining to the equipment.

#### 1-3. MAINTENANCE FORMS, RECORDS, AND REPORTS

##### a. Reports of Maintenance and Unsatisfactory Equipment

Department of the Army forms and procedures used for equipment maintenance will be those prescribed by DA Pam 738-750 as contained in Maintenance Management Update.

##### b. Report of Packaging and Handling Deficiencies

Fill out and forward SF 364 (Report of Discrepancy (ROD)) as prescribed in AR 735-11-2/DLAR 4140.55/NAVMATINST 4355.73A/AFR 400-54/MCO 4430.3F.

##### c. Discrepancy in Shipment Report (DISREP) (SF 361)

Fill out and forward Discrepancy in Shipment Report (DISREP) (SF 361) as prescribed in AR 55-38/NAVSUPINST 4610.33C/AFR 75-18/MCO P4610.19D/DLAR 4500.15.

#### 1-4. DESTRUCTION OF ARMY ELECTRONICS MATERIEL

Destruction of Army electronics materiel to prevent enemy use shall be in accordance with TM 750-244-2.

#### 1-5. ADMINISTRATIVE STORAGE

Administrative Storage of Equipment issued to and used by Army activities will have preventive maintenance performed in accordance with the PMCS

charts (page 2-11) before storing. When removing the equipment from administrative storage, the PMCS should be performed to assure operational readiness. Disassembly and repacking of equipment for shipment or limited storage are covered in TM 740-90-1, Administrative Storage of Equipment.

### 1-6. REPORTING EQUIPMENT IMPROVEMENT RECOMMENDATIONS (EIR)

If your Modem Radio Teletypewriter MD-522A/GRC needs improvement, let us know. Send us an EIR. You, the user, are the only one who can tell us what you don't like about your equipment. Let us know why you don't like the design. Tell us why a procedure is hard to perform. Put it on an SF 368 (Quality Deficiency Report). Mail it to: Commander, US Army Communications-Electronics Command and Fort Monmouth, ATTN: DRSEL-ME-MP, Fort Monmouth, New Jersey 07703. We'll send you a reply.

### 1-7. NOMENCLATURE CROSS-REFERENCE LIST

#### NOTE

Common names will be used when the major components of the MD-522A/GRC are mentioned in this manual. Official nomenclature must be used when completing report forms or when looking up technical manuals.

COMMON NAME	OFFICIAL NOMENCLATURE
Modem	Modem Radio Teletypewriter MD-522A/GRC

### 1-8. LIST OF ABBREVIATIONS

Abbreviations are spelled out the first time they appear in this manual. A list of abbreviations used in this manual is given below.

DX . . . . .	Duplex
FSK . . . . .	Frequency-Shift-Keyed
Hz . . . . .	Hertz
kc . . . . .	Kilocycles
kHz . . . . .	Kilohertz
mA . . . . .	Milliampere
MHz . . . . .	Megahertz
NSK . . . . .	Narrow Shift-Keyed
OWR . . . . .	One Way Reversible
PWR . . . . .	Power

RCV .....	Receive
RCVR .....	Receiver
rf .....	Radio frequency
SSB .....	Single Side Band
TRANS .....	Transmission
vdc .....	Volts direct current

**Section II. EQUIPMENT DESCRIPTION**

**1-9. PURPOSE, CAPABILITIES AND FEATURES**

- Used to provide single-channel, one-way reversible or duplex communication when used with radio transmitters and receivers.
- Used with standard teletypewriter equipment using 60-milliampere (mA) and 20 mA inputs and outputs.
- Operates as a modulator-demodulator within the system.

**1-10. DESCRIPTION**

- The modem is a self-contained unit. It consists of a front panel and chassis enclosed in a moistureproof case. All controls, connectors, and indicators are located on the front panel.
- Ž Two handles, one on the left and one on the right side of the case, make it easy to transport.

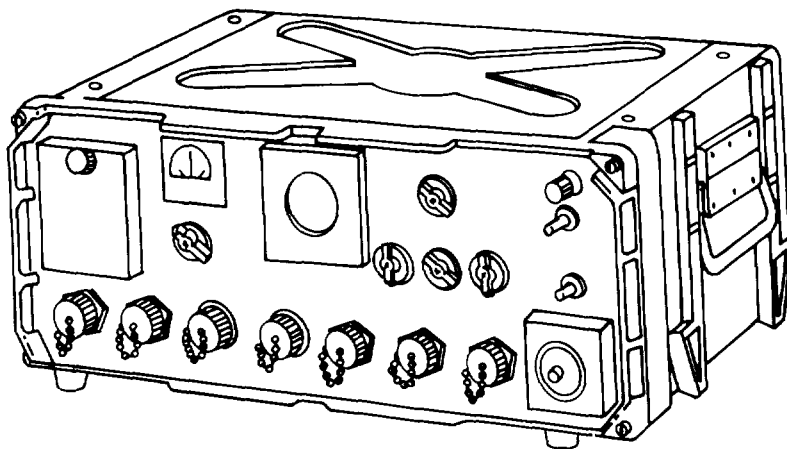

- Four feet are on the bottom of the modem case so it may be firmly seated in a modified mounting MT-3140/GRC-106 (used with, but not part of, the modem).

1-11. PERFORMANCE DATA

- TECHNICAL CHARACTERISTICS: Power requirements for the modem are 27.5 volts dc.
- MODES OF OPERATION: The chart below list the output for each mode of operation.

MODE OF OPERATION	OUTPUT
850 Hz shift (FSK) (transmit)	2,000 Hz ± 425 Hz shift
850 Hz shift (FSK) (receive)	2,000 Hz ± 1000 Hz with a ± 425 Hz shift
85 Hz shift (FSK)	2805 Hz ± 42.5 Hz
Voice	300-3,000 Hz
85 Hz Diversity (NSK)	2805 Hz ± 42.5 Hz & 25 Hz ± 42.5 Hz
85 Hz + Voice (NSK)	2805 Hz ± 42.5 Hz & Voice 200-2,300 Hz

1-12. WEIGHTS AND DIMENSIONS

WEIGHT	HEIGHT	WIDTH	DEPTH
36 pounds (16.32k)	7 inches (17.8cm)	22 inches (55.8cm)	13 inches (30.0cm)

## Section III. TECHNICAL PRINCIPLES OF OPERATION

### 1-13. SIMPLIFIED BLOCK DIAGRAM DESCRIPTION

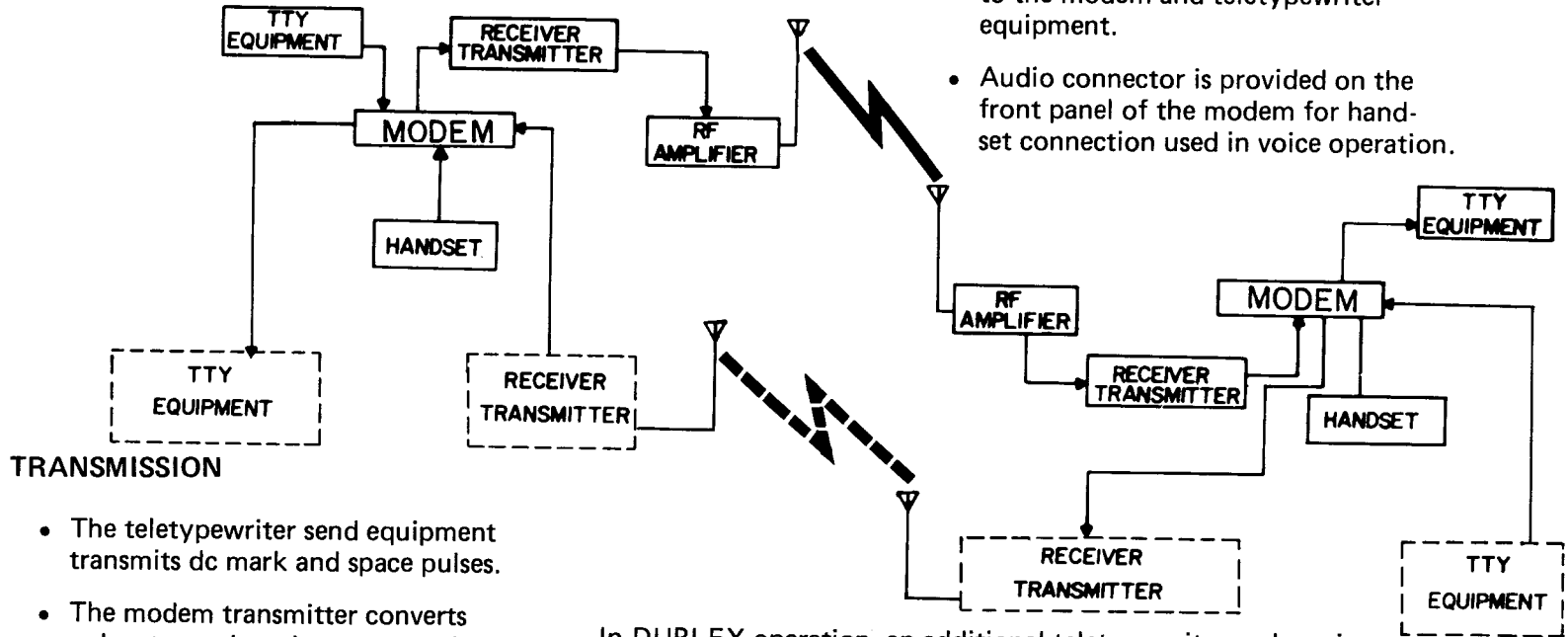

#### TRANSMISSION

- The teletypewriter send equipment transmits dc mark and space pulses.
- The modem transmitter converts pulses to mark and space tones in fsk or nsk format (depending on setting of mode selector switch).
- The modem output is applied to the receiver transmitter and rf amplifier for transmission over the link.

#### RECEPTION

- The received radio teletype signal is processed thru the rf amplifier receiver transmitter, and then applied to the modem and teletypewriter equipment.
- Audio connector is provided on the front panel of the modem for handset connection used in voice operation.

In DUPLEX operation, an additional teletypewriter and receiver-transmitter is required. This enables the system to transmit and receive at the same time.

**NOTE 1: SOLID LINES DENOTE ONE-WAY REVERSIBLE (OWR) OPERATION.**

**NOTE 2: DOTTED LINES DENOTE DUPLEX (DX) OPERATION.**

CHAPTER 2  
OPERATING INSTRUCTIONS

	PAGE
DC Loop No. 1, Current Checks . . . . .	2-14
DC Loop No. 2, Current Checks . . . . .	2-20
Description and Use of Operator's Indicators, Controls and Connectors . . . . .	2-1
Duplex Operation	
Reception . . . . .	2-20
Transmission . . . . .	2-20
OWR Checks . . . . .	2-13
Operating Procedures . . . . .	2-13
Operation Under Unusual Conditions . . . . .	2-22
Operation Under Usual Conditions . . . . .	2-12
Pony Circuit Operation . . . . .	2-21
PMCS Table . . . . .	2-11
Preparation for Use . . . . .	2-12
Preventive Maintenance Checks and Services (PMCS) . . . . .	2-8
Remote Operation . . . . .	2-22
Signal Tuning	
Alternate Method . . . . .	2-19
Preferred Method . . . . .	2-18
Start Procedure . . . . .	2-13
Stop Procedure . . . . .	2-22
Teletypewriter Reception . . . . .	2-17
Teletypewriter Transmission.. . . . .	2-15
Types of Operation . . . . .	2-12
Voice Reception . . . . .	2-16
Voice Transmission . . . . .	2-15



## Section I. DESCRIPTION AND USE OF OPERATOR'S INDICATORS, CONTROLS AND CONNECTORS

### 2-1. GENERAL INFORMATION

Each radio teletypewriter set uses different operating instructions for the modem. Special instructions are contained in the manual for each radio teletypewriter set used.

This section contains a descriptive guide of modem controls, indicators and connectors for the operator.

### 2-2. INDICATORS

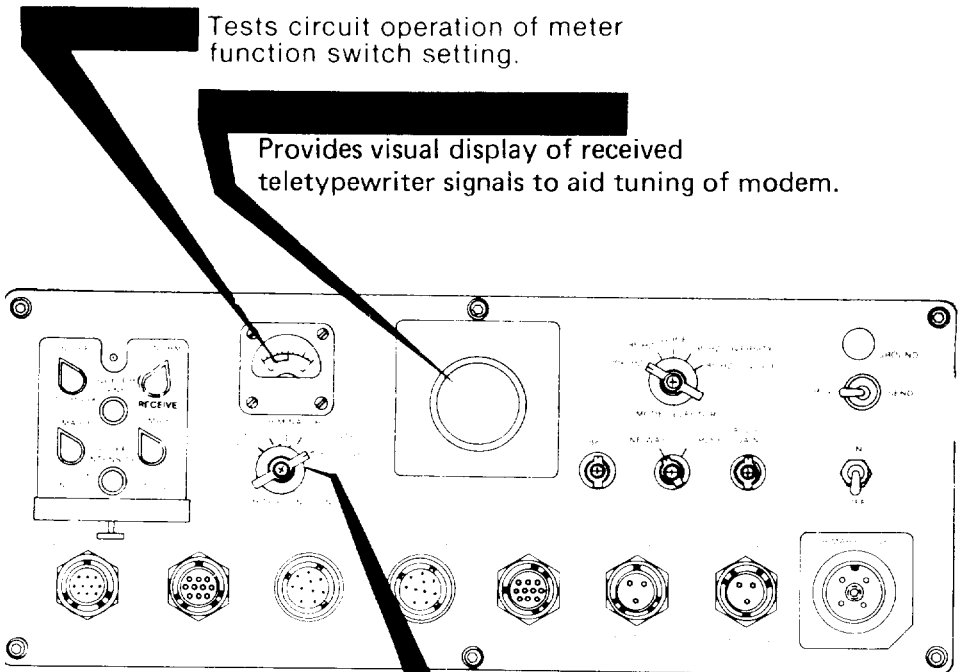

Tests circuit operation of meter function switch setting.

Provides visual display of received teletypewriter signals to aid tuning of modem.

### 2-3. CONTROLS

DC LOOP NO. 1	indicates direct current flow in dc loop No. 1.
DC LOOP NO. 2	indicates direct current flow in dc loop No. 2.
DISCRIMINATOR	indicates signal strength of received mark and space pukes.
REGULATED DC	indicates dc voltage level (+20 v) regulated dc supply.
RCV LEVEL	indicates signal strength of receive (audio) signals.

Adjusts center frequency of received 850-Hz signals.

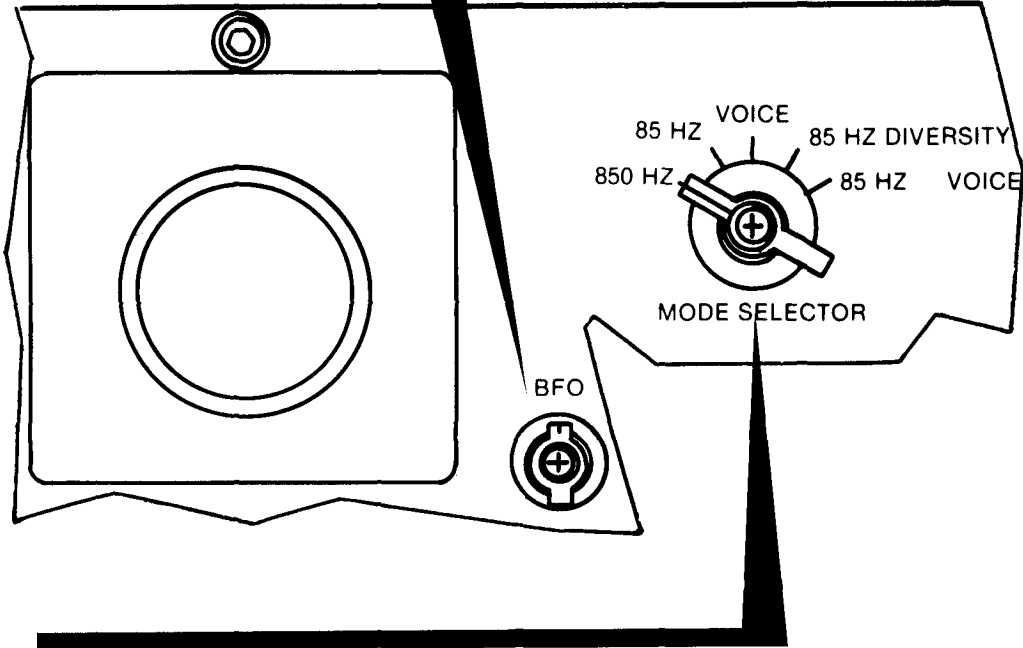

The position of this switch selects the mode of operation.

- 850 HZ position selects 850-Hz fsk operation.
- 85 HZ position selects 85-Hz fsk operation,
- VOICE position selects only voice operation.
- 85 HZ DIVERSITY position selects a dual 85-Hz operation with a center frequency of 2805 or 425 Hz. Both signals are transmitted at the same time, but the receive section uses only the stronger signal.
- 85 HZ+ VOICE position selects operation of voice and 85-Hz nsk at the same time.

Provides ground connection for modem.

**NOTE**

Before operating RCV/SEND switch, check ONE WAY/DUPLEX switch for ONE WAY position.

RCV position permits reception.  
SEND position permits transmission.

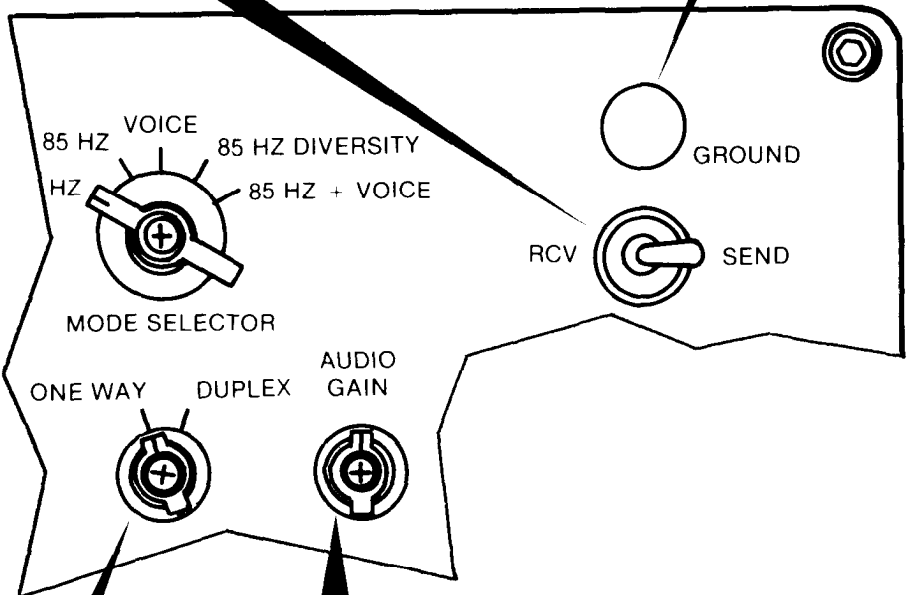

Regulates audio output level to headset and loudspeaker.

ONE WAY position permits either reception or transmission.  
DUPLEX position permits reception and transmission at the same time.

ON position applies power to modem.  
OFF position removes power.

Connects teletypewriter to modem for reception in duplex operation.

Connects teletypewriter to the modem for one-way reversible operation.

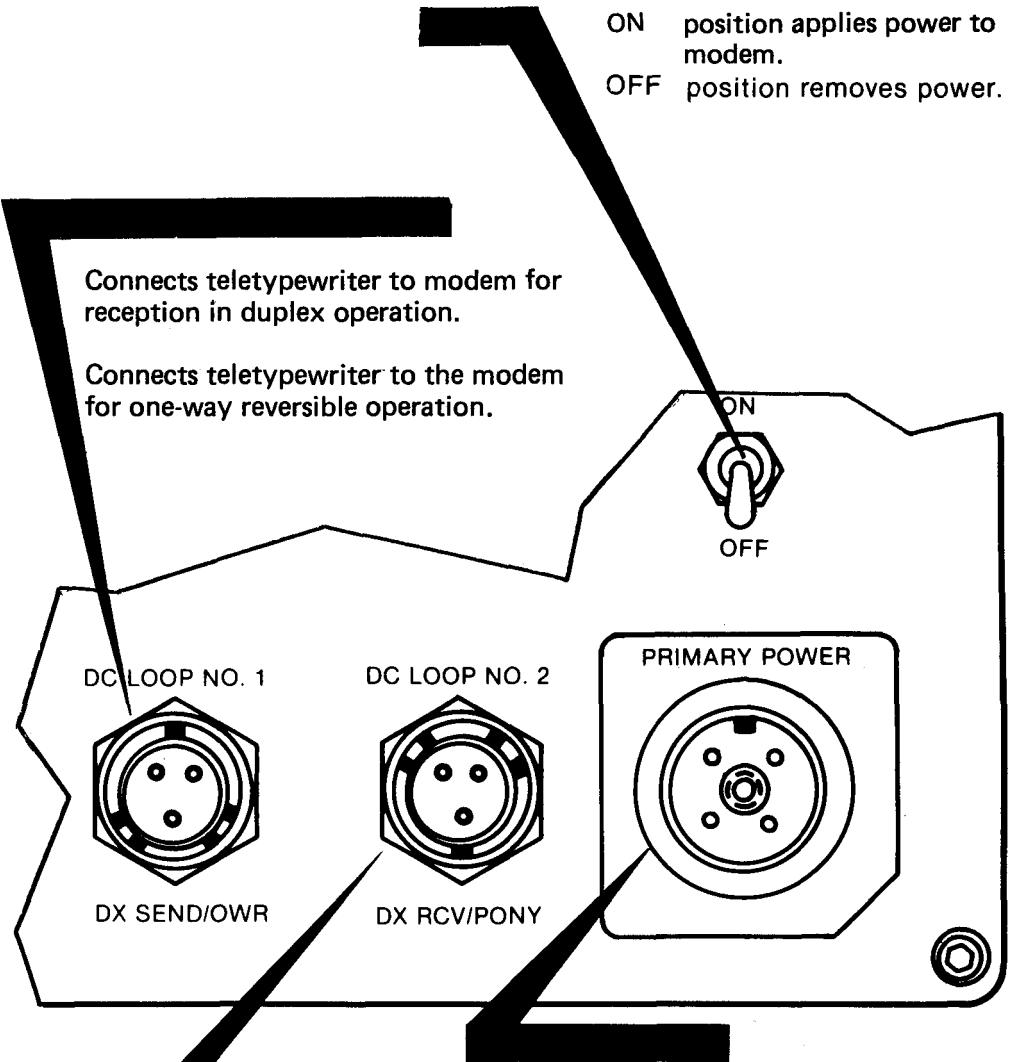

Connects 27.5 volts dc from main power line to the modem.

Connects teletypewriter to modem for reception in duplex operation.

Provides pony circuit (order wire overland lines) loop current during one-way position.

A pony loop circuit allows teletypewriter order wire transmission and reception over landlines from a remote station when the system is not operating in the duplex mode.

**CAUTION**

The voltage output of the auxiliary connector is not regulated, fused, or protected. Therefore, unprotected equipment supplied with power from the auxiliary connector may be damaged by using the wrong polarity or line spikes.

Provides power (27.5 vdc) to control equipment.  
Used for local or remote control function.

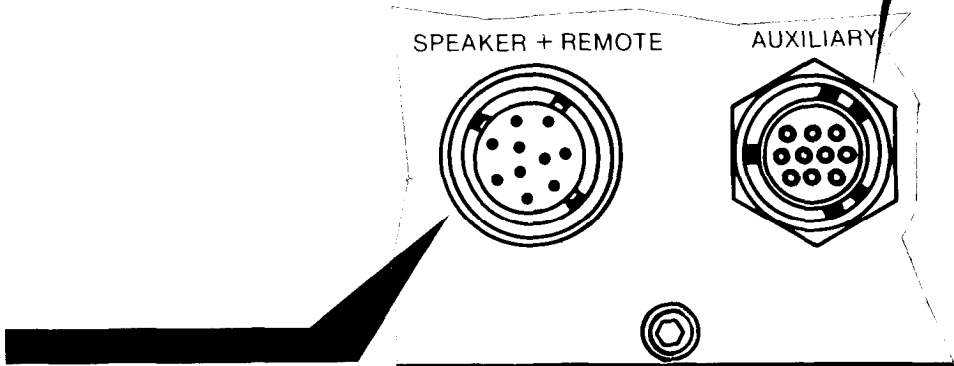

Provides connection for an audio input to the modem and for an audio output to loudspeaker. May be used with other equipment for remote operation.

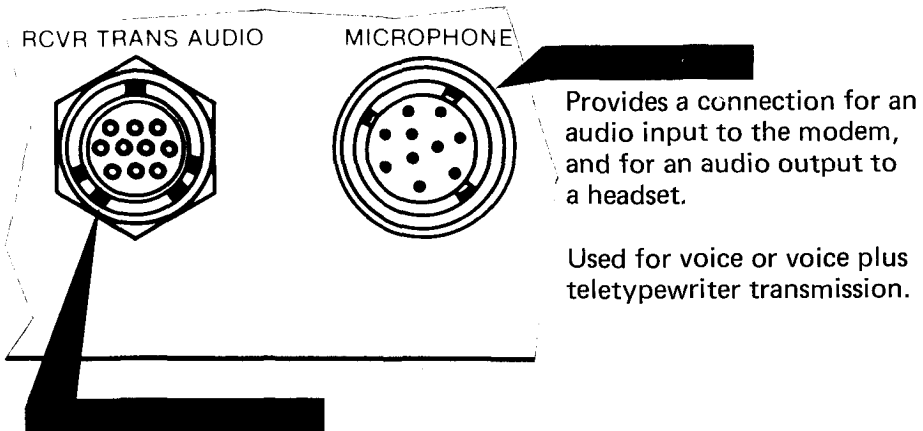

Provides a connection for an audio input to the modem, and for an audio output to a headset.

Used for voice or voice plus teletypewriter transmission.

Used in duplex and one-way reversible operation to connect audio output circuit from modem to exciter section of receiver-transmitter.

Used in one-way reversible operation to connect audio output from receive section of receive-transmitter to modem.

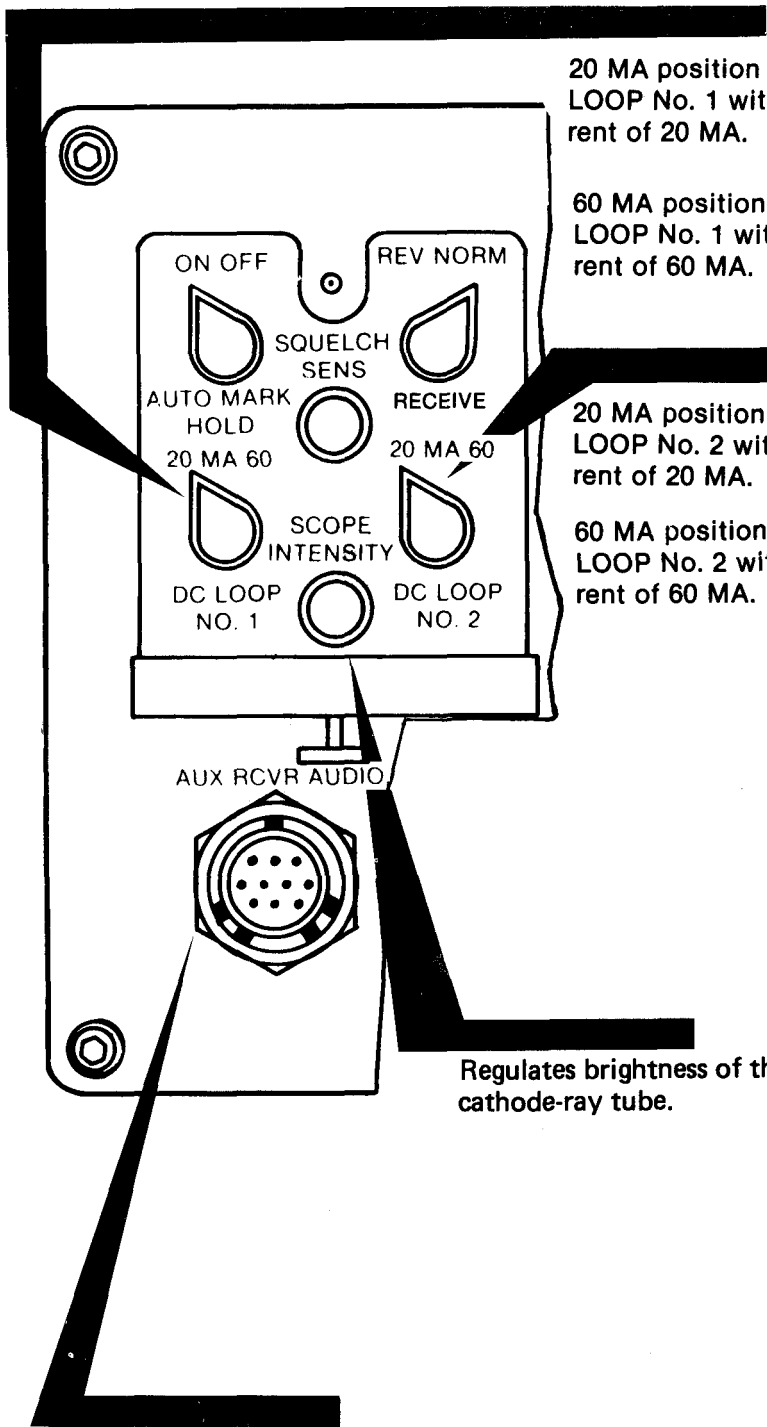

Used in duplex operation to connect audio output of auxiliary receiver to modem.

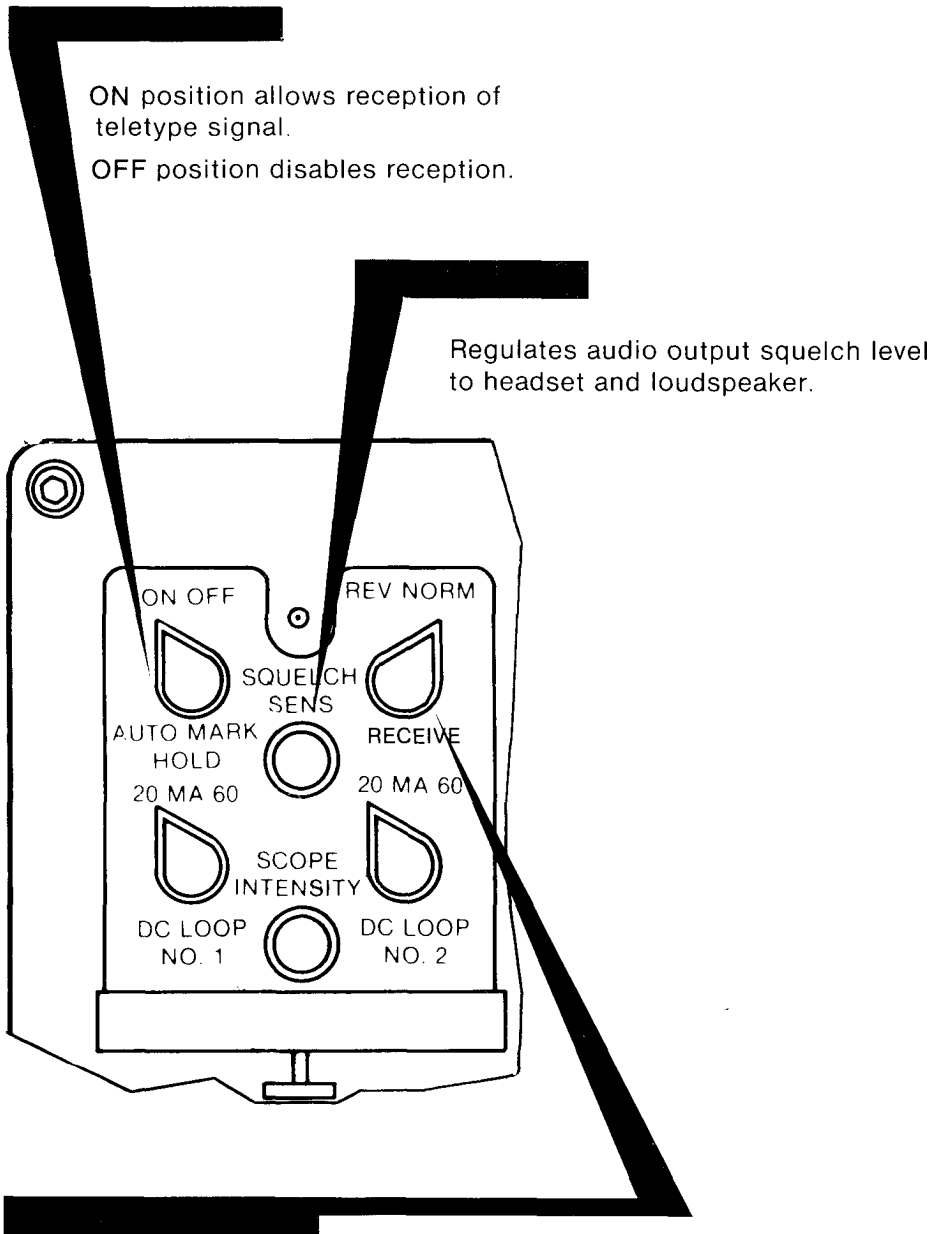

NORM position allows reception of teletype signal by use of normal mark-space polarities.

REV position allows reception of teletype signal by reversing normal polarities for mark and space polarities.

## Section II. PREVENTIVE MAINTENANCE CHECKS AND SERVICES

### 2-5. PREVENTIVE MAINTENANCE

The maintenance duties of the operator are to perform a prescribed sequence of preventive maintenance checks and services. The preventive maintenance procedures are the systematic care, servicing, and inspection of equipment to prevent the occurrence of trouble and to reduce downtime by detecting and correcting the problems. These checks and services are to maintain Army electronic equipment in a combat serviceable and mission ready condition.

#### a. Tools, Materials, and Equipment Required for Maintenance

No tools or equipment are required for operator maintenance. The following cleaning materials will be useful to the operator.

- Lint-free cloths (item 1, app. D)
- Soft bristle brush (item 2, app. D)
- Dishwashing detergent (item 3, app. D)
- Cleaning compound (item 2, app. D)

#### NOTE

If your modem must be in **USE ALL THE TIME**, check and service those items that can be checked and serviced without stopping its operation. Make **COMPLETE** checks and services **ONLY** when the modem is finally **SHUT DOWN**.

#### b. Routine Services

Routine services are a collection of checks and observations performed by the operator at all times. Routine services are not listed in the preventive maintenance checks and services table, in order to separate the nonoperational from the operational services.

You should perform the following routines as necessary.

- Clean
- Dust
- Wash
- Check controls for smooth operation
- Cover unused receptacles
- Check for completeness of equipment



**c. Explanation of INTERVAL column of PMCS chart**

- BEFORE OPERATION** – Do your Before (B) PMCS to be sure the radio set is ready to use.
- DURING** – Do your During (D) PMCS while you operate your modem, to help spot small problems before they become big problems.
- MONTHLY** – Do your Monthly (M) PMCS to insure that the modem is functioning properly.

**NOTE**

**ALL PMCS must be done as regularly scheduled and also under the following conditions:**

- Before the modem is used on a mission.
- When the modem is first installed.
- When the modem is re-installed after being removed for any reason.
- You are operating the modem for the first time.

**d. Explanation of EQUIPMENT IS NOT READY IF: column of PMCS chart.**

- This column tells the condition under which the equipment can not perform the assigned mission requirements.

**e. Explanation of ITEM TO BE INSPECTED PROCEDURE column of PMCS chart.**

This column specifies the item to be inspected and the procedures to perform the required checks and services. Carefully follow these instructions. If tools are needed, or the chart instructions tell you tools are needed, get organizational maintenance to do the necessary work.

**NOTE**

If any portion of your modem fails to operate, refer to chapter 3 under troubleshooting for possible problems. Report any malfunctions or failures on the proper DA Form 2404 (page 2-10) or, refer to DA Pam 738-750.

DA FORM 2404, EQUIPMENT INSPECTION AND MAINTENANCE WORKSHEET

EQUIPMENT INSPECTION AND MAINTENANCE WORKSHEET						
For use of this form, see TM 11-750; the proponent agency is the Office of the Deputy Chief of Staff for Logistics.						
1. ORGANIZATION Company A 210 SIG. BATTALION			2. NOMENCLATURE AND MODEL RADIO TELETYPEWRITER Model 572			
3. REGISTRATION/SERIAL/FSN 5815-00-919-4700	4a. MILES	b. HOURS	c. ROUNDS FIRED	d. HOT STARTS	5. DATE 13 Nov. 81	6. TYPE INSPECTION PMCS
7. APPLICABLE REFERENCE						
TM NUMBER 11-5805-387-10-2	TM DATE 12 Nov '81	TM NUMBER	TM DATE			
INSTRUCTIONS - Perform each check listed in the TM applicable to the inspection performed. Following the sequence listed in pertinent TM, complete form as follows:						
COLUMN a - Enter TM item number.			COLUMN d - Show corrective action for deficiency or shortcoming listed in Column c.			
COLUMN b - Enter the applicable condition status symbol.			COLUMN e - Individual ascertaining completed corrective action initial in this column.			
COLUMN c - Enter deficiencies and shortcomings.						
ALL INSPECTIONS AND EQUIPMENT CONDITIONS RECORDED ON THIS FORM HAVE BEEN DETERMINED IN ACCORDANCE WITH DIAGNOSTIC PROCEDURES AND STANDARDS IN THE TM CITED HEREON.						
8a. SIGNATURE (Person(s) performing inspection) John Doe	8b. TIME 0.1 hr.	9a. SIGNATURE (Maintenance Supervisor) Sgt. James Johnston	9b. TIME 0.1 hr.	10. MANHOURS REQUIRED 0.2 hrs.		
TM ITEM NO. 1	STATUS a	DEFICIENCIES AND SHORTCOMINGS Radio teletypewriter Model 572 does not work properly		CORRECTIVE ACTION Notify Organization Maintenance		INITIAL WHEN CORRECTED JD

**TABLE 2-1. PREVENTIVE MAINTENANCE CHECKS AND SERVICES (PMCS)**  
**B – BEFORE OPERATION      D – DURING OPERATION      M – MONTHLY OPERATION**

ITEM NO.	INTERVAL			ITEM TO BE INSPECTED	PROCEDURE	EQUIPMENT IS NOT READY/AVAILABLE IF:
	B	D	M			
				<u><b>WARNING</b></u>  Do not operate equipment until all URGENT MWOs have been applied.		
1			•	Modem	Check that all URGENT MWOs have been applied.	URGENT MWOs have not been applied.
2	*			Operate the equipment as described in section III, chapter 2, of this manual.		Equipment cannot be operated. Mission cannot be accomplished.
3			•	Headset	a. Put on headset. b. Attach microphone at microphone connection. c. Press and hold switch to key microphone and talk. d. Note sidetone in headset.	No sidetone in headset.
4			•	Meter Indicator	Set METER FUNCTION switch to a particular function.	Meter indicator does not work, or improper indication results.

\*Perform prior to deployment to a mission location for the purpose of determining and correcting equipment malfunctions prior to actual mission operation.

### Section III. OPERATION UNDER USUAL CONDITIONS

#### 2-6. TYPES OF OPERATION

- The modem is always used as part of a communication system.  
Type of operation is controlled by the system installation used.
- The modem can be used for local or remote operation.
- One-way reversible or duplex types of operation can be performed to transmit and/or receive the following signals:
  - fsk (850 Hz)
  - fsk (85 Hz)
  - voice only
  - nsk diversity (85 Hz diversity)
  - nsk plus voice (85 Hz + voice)

**ONE-WAY REVERSIBLE:** use to receive or transmit.  
**DUPLEX:** use to receive and transmit at the same time.  
**PONY CIRCUIT:** use to receive or transmit between local and remote.

#### 2-7. PREPARATION FOR USE

Pull down hinged cover at the top left side of the modem front panel, to locate additional controls and switches needed to operate the modem.

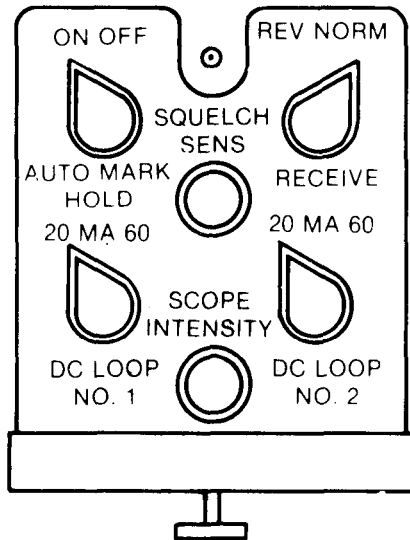

**2-8. PRESET START PROCEDURE**

**START PROCEDURE**

**NOTE**

Always allow the modem 10 minutes to warm up before you operate it.

- Apply power to the modem by setting ON/OFF switch to ON.



- Be sure RCV/SEND switch is in RCV position.

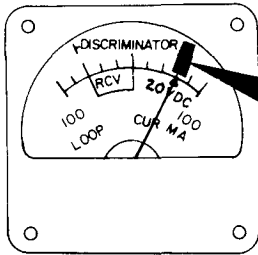

- Set METER FUNCTION switch to REGULATED DC.



- If improper indication is observed, see troubleshooting table, chapter 3.
- See chapter index to determine the correct paragraph for required operation.

**2-9. ONE-WAY REVERSIBLE (OWR) OPERATION**

**a. DC LOOP NO. 1 CURRENT CHECKS**

- Set METER FUNCTION switch at DC LOOP NO. 1

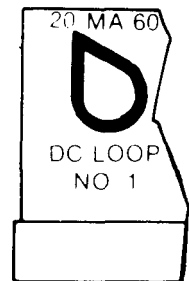
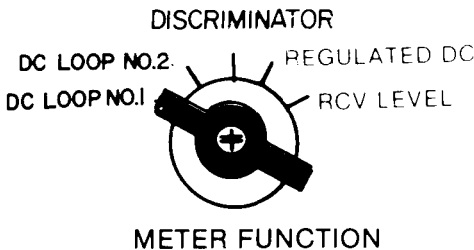

- Set DC LOOP NO. 1 switch to 20 MA or 60 MA, whichever is needed.

(Check for loop current as follows: next page)

- Turn off audio input to the modem by turning the receiver-transmitter **AUDIO GAIN** fully counterclockwise.

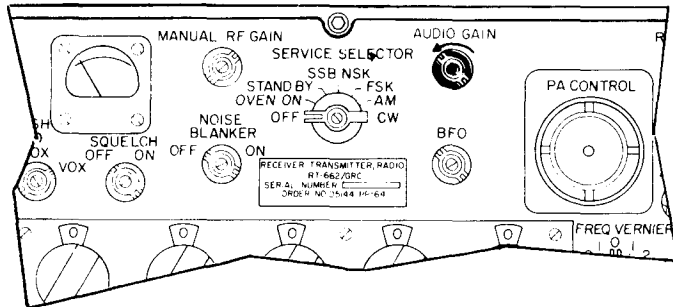

- Check meter for direct current (20 or 60 mA) flowing through DC LOOP NO. 1

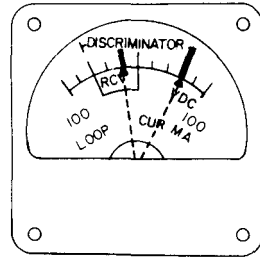

To maintain loop current flow set **AUTO MARK HOLD** switch to **ON** position.

**NOTE**

Meter will register in the right scale (upscale) when loop battery module **INTERNAL-EXTERNAL** switch is in **INTERNAL** position. Meter will read in the left scale (downscale) when in **EXTERNAL** position.

**b. VOICE TRANSMISSION**

- Set **MODE SELECTOR** at **VOICE** or **85 Hz + VOICE**.
- Check that the **METER FUNCTION** switch is at **DC LOOP NO. 1**.

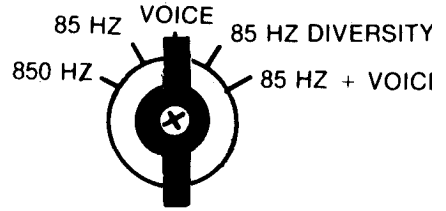

Set the **RCV/SEND** switch to **SEND**.



- Check **ONE WAY/DUPLEX** switch for **ONE WAY** position.
- Attach microphone at microphone connector.
- Press and hold switch to key microphone and talk.
- Note sidetone in headset.

- Make any adjustments necessary at receiver-transmitter to transmit voice signals (Refer to appropriate technical manual.)

**c. TELETYPEWRITER TRANSMISSION**

- Set **METER FUNCTION** switch to **DC LOOP NO. 1**.
- Set **MODE SELECTOR** switch to position desired.

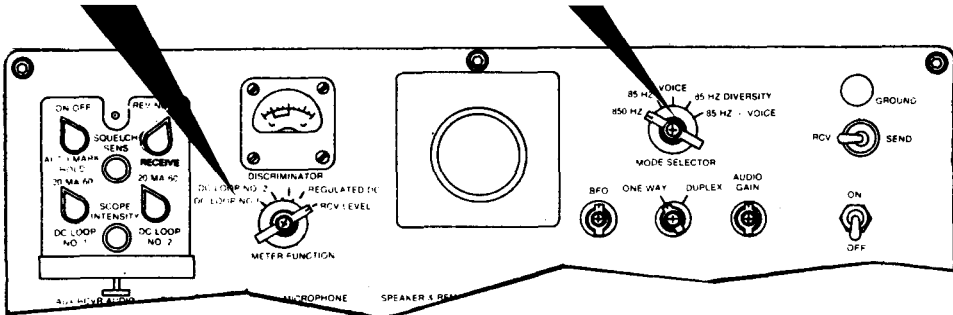

- Set **ONE WAY/DUPLEX** switch to **ONE WAY** position. Set **RCV/SEND** switch to **SEND** position.
- Check meter to see that it registers between 0 and 20 mA (depending on the setting of **DC LOOP NO. 1** switch).
- Make adjustments if necessary on the receiver-transmitter to transmit signal.
- When teletypewriter transmission is finished set **RCV/SEND** at **RCV**.

**d. VOICE RECEPTION**

- Set MODE SELECTOR at VOICE or 85 Hz + VOICE.

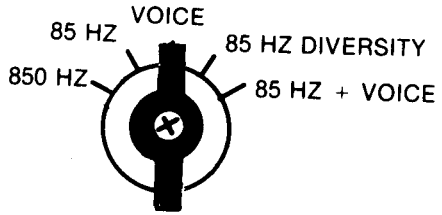

- Tune receiver-transmitter (or telephone isolation amplifier) to the correct frequency, and fine tune as necessary for correct operation.

- Set RECEIVE switch at NORM.

- Set RCV/SEND to RCV.

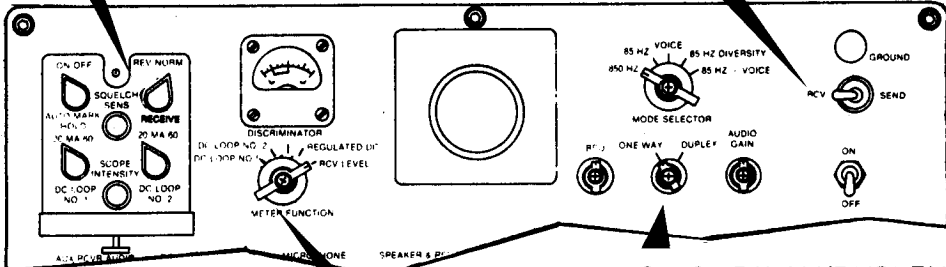

- Set ONE WAY/DUPLEX switch to ONE WAY.

- Set METER FUNCTION at RCV LEVEL.

**NOTE**

A signal must be received at receiver-transmitter or telephone isolation amplifier in order to properly adjust AUDIO GAIN controls.

- Adjust AUDIO GAIN at receiver-transmitter (or telephone isolation amplifier) until modem METE R registers within the boxed area marked RCV.

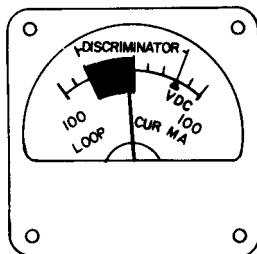



- Adjust the modem AUDIO GAIN control as needed for desired audio level at headset or loudspeaker.

AUDIO  
GAIN



- Return METER FUNCTION switch to DC LOOP NO. 1.
- Adjust SQUELCH SENS control as needed for desired degree of background audio squelching at the headset or loudspeaker. (Full clockwise turn provides maximum squelch. )

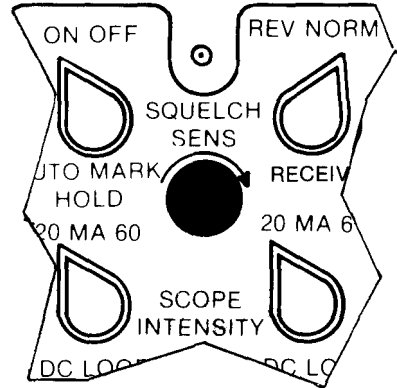

e. TELETYPEWRITER RECEPTION

- Set MODE SELECTOR switch to position desired.

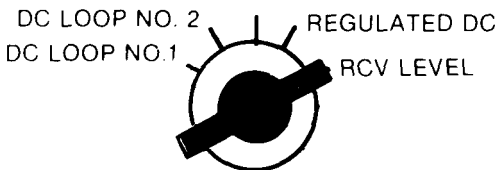
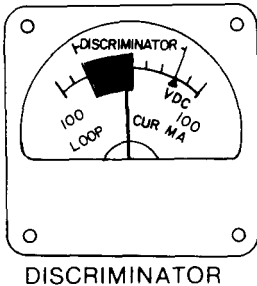
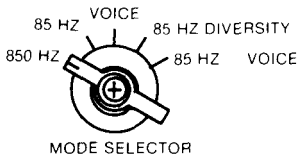

- Set RCV/SEND at RCV.
- Check ONE WAY/DUPLEX switch for ONE WAY position.
- Set METER FUNCTION to RCV LEVEL.
- When a signal is present, adjust AUDIO GAIN control on receiver-transmitter until you get a reading in RCV portion of meter.

**NOTE**

If you do not get a correct reading on the meter, repeat procedures given for voice reception.

**2-10. PREFERRED AND ALTERNATE METHOD OF TUNING**

Use the preferred method to tune the signal.

If the scope is not working, the preferred method cannot be used to tune the signal. Use the alternate method (para 2-10b.)

**a. PREFERRED METHOD**

- Tune the receiver-transmitter until you get a correct trace pattern on the scope.

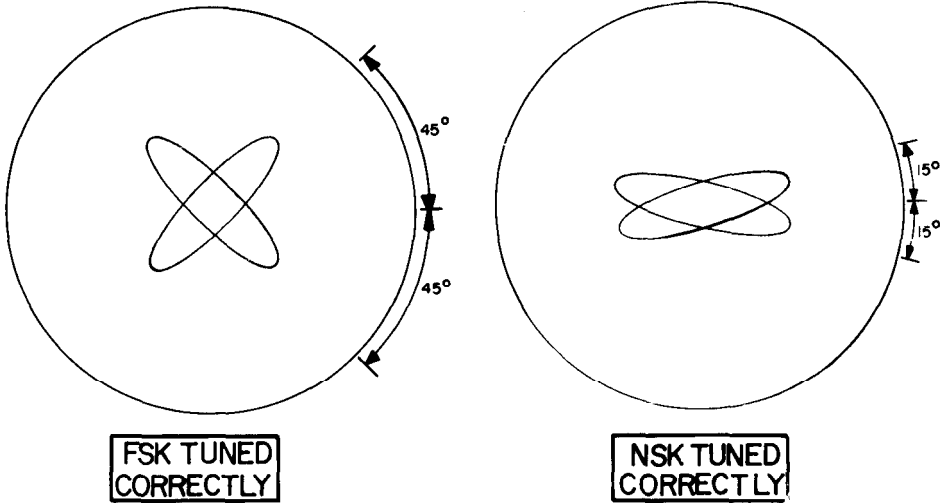

**NOTE**

When the modem is warmed up, 5 minutes will be necessary for the BFO to stabilize. If the modem is cold, 15 minutes will be necessary for BFO to become stable. Make necessary adjustments during these time periods to maintain the best signal reception display on the scope.

- In 850-Hz mode only, use the modem BFO control to aid fine tuning, until you get a correct trace pattern. In all other modes, tune with **FREQ VERNIER** control on receiver-transmitter.



**CAUTION**

Adjust **SCOPE INTENSITY** control to the **MINIMUM** level necessary for adequate display to avoid damage to the face of the cathode ray tube (CRT).

- Adjust SCOPE INTENSITY control to obtain adequate display.

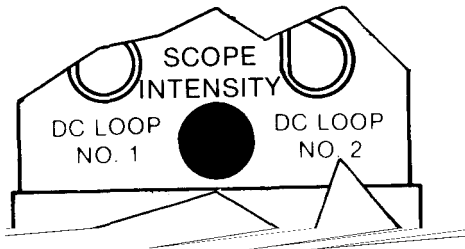

b. ALTERNATE METHOD

COARSE TUNE the signal as follows:

Set METER FUNCTION at DISCRIMINATOR.

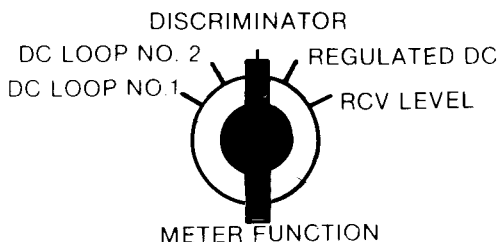

Tell sending station to send a series of teletypewriter test signals using the following R-Y codes.

- (1) R-Y.
- (2) The quick brown fox jumped over the lazy dog's back.
- (3) Now is the time for all good men to come to the aid of their country.

- Watch the modem meter. It will indicate signal strength of mark and space pulses.

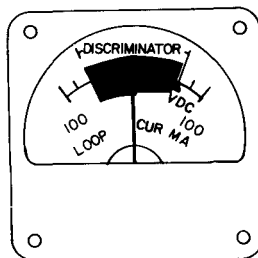

- Tune the receiver and modem BFO (850-Hz mode only) until the meter registers in the DISCRIMINATOR scale during the entire message. (Tune so that the indicator needle swings the maximum range within the discriminator section of the meter. )
- Set METER FUNCTION to DC LOOP NO. 1

- Check meter to see that it registers between 0 and 20 mA, depending on the setting of DC LOOP NO. 1 switch.
- Check teletypewriter machine printout. If you cannot read the print out, place modem RECEIVE switch at REV. Check again for a satisfactory print out.

**2-11. DUPLEX OPERATION**

**TRANSMISSION**

- Perform the preset procedure for OWR (para 2-8).
- Turn ONE WAY/DUPLEX switch to DUPLEX.

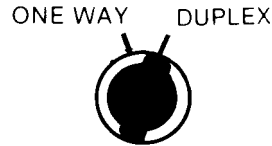

- Repeat procedures for voice transmission and teletypewriter transmission as described in paragraphs 2-9(b) and (c).
- To operate, set AUTO MARK HOLD switch to desired position (ON or OFF).



**RECEPTION**

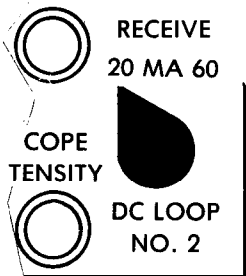

- Set DC LOOP NO. 2 switch at 20 or 60 MA, as needed.

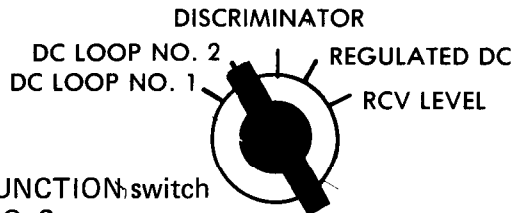

- Set METER FUNCTION switch at DC LOOP NO. 2.

**2-12. DC LOOP NO. 2 CURRENT CHECK**

- Turn off audio input to the modem by turning the receiver-transmitter AUDIO GAIN fully counterclockwise.

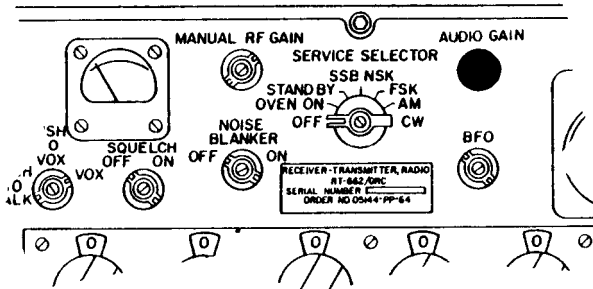

- Check meter to see that correct current flow (20 or 60 mA) is in dc loop no. 2.

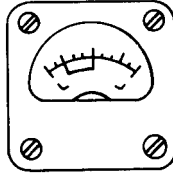

REPEAT PROCEDURES FOR VOICE RECEPTION AND TELETYPE-WRITER RECEPTION AS DESCRIBED IN PARAGRAPHS 2-9(d) AND 2-9(e) ABOVE.

**2-13. PONY CIRCUIT OPERATION: TRANSMISSION AND RECEPTION**

- Prepare pony circuit base and remote station teletypewriter machines for operation.
- Turn DC LOOP NO. 2 switch to 20 MA or 60 MA as needed.



- Set ONE WAY/DUPLEX switch to ONE WAY.



- Adjust base teletypewriter to produce steady mark output.
- Turn METER FUNCTION switch to DC LOOP NO. 2.



- Check meter to see that correct current flow (20 or 60 mA) is in pony circuit loop.

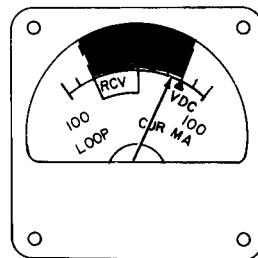

**NOTE**

For DC LOOP NO. 2, meter will register in right scale (upscale) when loop battery module INTERNAL-EXTERNAL switch is in the INTERNAL position. Meter will register in left scale (downscale) when in EXTERNAL position.

**2-14. REMOTE OPERATION**

Modem remote operation is described in the technical manual for each type of system and remote control used.

Usually modem is pre-set in a correct operating mode and remotely keyed.

**2-15. STOPPING PROCEDURE**

- Set RCV/SEND switch at RCV.
- To disable modem, place ON/OFF switch to OFF position.



**Section IV. OPERATION UNDER UNUSUAL CONDITIONS**

Since the modem must be used as part of a system, operation under unusual conditions may be found in the manual for the specific radio teletypewriter set with which it is used. Refer to TM-5815-334-10, chapter 2, section IV for specifics on cold weather operation.



CHAPTER 3

MAINTENANCE INSTRUCTIONS

	<b>PAGE</b>
Cleaning .....	3-2
Routine Inspection .....	3-2
Circuit Breaker Check .....	3-1
Maintenance Procedures.. ..	3-2
Troubleshooting	
Procedures .....	3-1
Table .. ..	3-1



Section I. TROUBLESHOOTING

3-1. CIRCUIT BREAKER CHECK



Operator's troubleshooting will be limited to checking the front panel ON/OFF circuit breaker and ONE WAY/DUPLEX switch.

3-2. TROUBLESHOOTING PROCEDURES

The troubleshooting table tells you some of the troubles you may find during the operation or maintenance of the modem. You should perform the test, inspections, and corrective actions in the order listed.

This manual cannot cover all the troubles that may happen, nor all the tests, inspections or corrective actions. If a trouble is not listed or it cannot be corrected by performing the corrective actions, notify your supervisor.

TROUBLESHOOTING TABLE

MALFUNCTION	TEST OR INSPECTION	CORRECTIVE ACTION	ON  OFF
1. Power cannot be applied to the modem.	<ul style="list-style-type: none"> <li>◦ Turn circuit breaker to ON position.</li> </ul>	<ul style="list-style-type: none"> <li>◦ If the circuit breaker fails to stay in ON position, do not force; higher level maintenance required.</li> </ul>	
2. RCV/SEND switch will not operate.	<ul style="list-style-type: none"> <li>◦ Check ONE WAY/DUPLEX switch for ONE WAY position.</li> </ul>	<ul style="list-style-type: none"> <li>◦ Turn ONE WAY/DUPLEX switch to ONE WAY position.</li> </ul>	

## Section II. MAINTENANCE PROCEDURES

### 3-3. INTRODUCTION

Operator's maintenance consists of: performing preventive maintenance checks and services, troubleshooting, and cleaning the modem.

### 3-4. ROUTINE INSPECTION

Check all interconnecting cables and connectors for cracks and breaks.

Check to see that meter face (glass) is not broken or loose.

Check to see that knobs are tight, and controls function properly.

### 3-5. CLEANING

#### WARNING

Do not clean equipment if the power is on.

Remove dust and loose dirt from outside surfaces of the modem with a clean, soft cloth, (item 1, app. D). Cloth may be dampened with water, and mild soap (item 3, app. D) may be used for better cleaning. Clean dust or dirt from plugs and jacks with a brush (item 2, app. D).

#### WARNING

See trichlorotrifluoroethane warning on page B.

#### WARNING

See compressed air warning on page B.

#### CAUTION

Do not press on meter face (glass) when cleaning. The meter may be damaged.

Remove grease, fungus and ground-in dirt from modem case. Use cloth dampened with cleaning compound (item 4, app. D).

APPENDIX A  
REFERENCES

A-1. INTRODUCTION

The Consolidated Index of Army Publications and Blank Forms, DA PAM 310-1, should be consulted frequently for revisions, and new publications that pertain to this manual. The following is a list of all forms, technical manuals, and publications referenced in this manual.

A-2. FORMS

- DA Form 2028 . . . . . Recommended Changes to Publications and Blank Forms
- DA Form 2404 . . . . . Equipment Inspection and Maintenance Worksheet
- SF Form 361 . . . . . Discrepancy in Shipment Report
- SF Form 364 . . . . . Report of Discrepancy (ROD)
- SF Form 368 . . . . . Quality Deficiency Report

A-3. TECHNICAL MANUALS

- TM 11-5805-387-10-2 . . . . . Operator's Manual: Modem Radio Teletype MD-522A/GRC
- TM 11-5820-520-10-1 . . . . . Operator's Manual: Radio Sets AN/GRC-106 and AN/GRC-106A
- TM 740-90-1 . . . . . Administrative Storage of Equipment
- TM 750-244-2 . . . . . Procedures for Destruction of Electronics Materiel to Prevent Enemy Use (Electronics Command)

**A-4. MISCELLANEOUS PUBLICATIONS**

- AR 385-11 . . . . . Ionizing Radiation Protection (Licensing Control, Transportation, Disposal, and Radiation Safety)
- DA PAM 310-1 . . . . . Consolidated Index of Army Publications and Blank Forms
- DA PAM 738-750 . . . . . The Army Maintenance Management System (TAMMS)
- SC-5180-91-CL-R . . . . . Sets, Kits, and Outfits, Component List: Tool Kit, Electronics Equipment, TK 101/G
- TB 43-0116 . . . . . Identification of Radioactive Items in the Army Supply System
- TB 43-0122 . . . . . Instructions for the Safe Handling and Identification of US Army Communication-Electronics Command Managed Radioactive Items in the US Army



**APPENDIX B**  
**COMPONENTS OF END ITEM AND BASIC ISSUE ITEMS LISTS**

**Section I. INTRODUCTION**

**B-1. SCOPE**

The Components of End Item and Basic Issue Items Lists are divided into the following sections:

**a. Section II. Components of End Item.** This listing is for informational purposes only and is not authority to requisition replacements. These items are part of the end item, but are removed and separately packaged for transportation or shipment. As part of the end item, these items must be with the end item whenever it is used or transferred between property accounts. Illustrations are furnished to assist you in identifying the items.

**B-2. GENERAL**

This appendix lists components of end item and basic issue items for the MD-522A/GRC to help you inventory items required for safe and efficient operation.

**b. Section III. Basic Issue Items.** These are the minimum essential items required to place the modem in operation, to operate it, and to perform emergency repairs. Although shipped separately packaged BII must be with the modem during operation and whenever it is transferred between property accounts. The illustrations will assist you with hard-to-identify items. This manual is your authority to request/requisition replacement BII, based on TOE/MTOE authorization of the end items.

**B-3. EXPLANATION OF COLUMNS**

The following provides an explanation of columns found in the tabular listings:

**a. Column (1) - Illustration Number (Illus. Number).** This column indicates the number of the illustration in which the item is shown.

**b. Column (2) - National Stock Number.** Indicates the National stock number assigned to the item and will be used for requisitioning purposes.

**c. Column (3) - Description.** Indicates the National item name and, if required, a minimum description to identify and locate the item. The last line for each item indicates the FSCM (in parentheses) followed by the part number. If item needed differs from different models of this equipment, the model is shown under the "Usable On" heading in this column.

**d. Column (4) - Unit of Measure (U/M).** Indicates the measure used in performing the actual operation/maintenance function. This measure is expressed by a two-character alphabetical abbreviation (e.g, ea, in, pr).

**e. Column (5) - Quality required (Qty rqr).** Indicates the quantity of the item authorized to be used with/on the equipment.

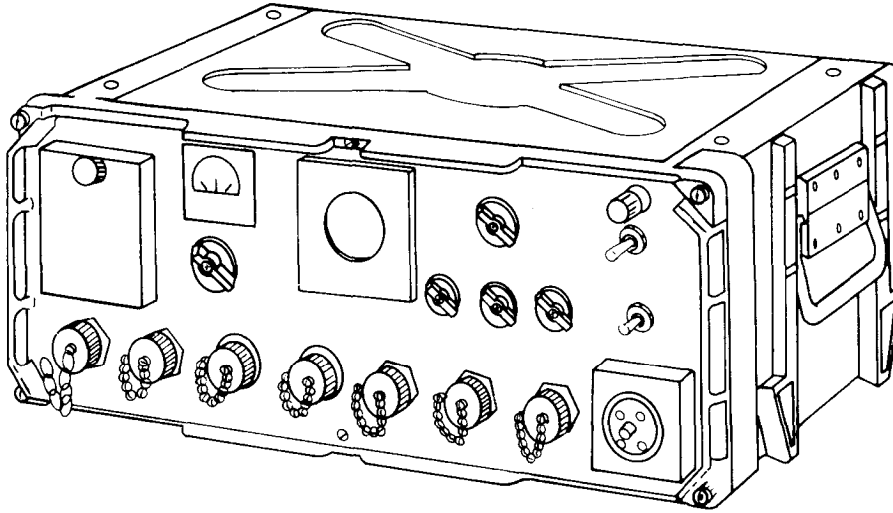

**Section II. COMPONENTS OF END ITEM**

(1) LLUS NO.	(2) NATIONAL STOCK NUMBER	(3) DESCRIPTION  USABLE (FSCM) AND PART NUMBER ON CODE	(4) U/M	(5) QTY REQD
1	5815-00-919-4800	Radio Teletypewriter, Modem MD-522A/GRC.	EA	1

Section III. BASIC ISSUE ITEMS

(1) LLUS NO.	(2) NATIONAL STOCK NUMBER	(3) DESCRIPTION  USABLE (FSCM) AND PART NUMBER ON CODE	(4) U/M	(5) QTY REQD
	5815-00-919-4800	Operator's Manual: Modem Radio Teletypewriter MD-522A/GRC		1





## APPENDIX D

## EXPENDABLE SUPPLIES AND MATERIALS LIST

## Section I. GENERAL INFORMATION

## D-1. INTRODUCTION

This appendix lists expendable supplies and materials you will need to operate and maintain the MD-522A/GRC.

## D-2. EXPLANATION OF COLUMNS

a. ITEM NO. This number is referenced in the narrative instructions to identify the material (for example, "Use cleaning compound, item 2, app. D).

b. LEVEL. Shows the lowest level of maintenance that needs the listed item.

C - Crew/Operator

c. NATIONAL STOCK NUMBER. Shows the National Stock Number assigned to each item and used to requisition that item.

d. DESCRIPTION. Shows the Federal Item Name and (if required) a short description to identify and locate the item, The last line for each item shows the Federal Supply Code for Manufacturers (FSCM) in parentheses followed by the part number.

e. UNIT OF MEASURE (U/M). Shows the measure of the item needed to perform the actual operational/maintenance function. This measure is shown by a two-letter abbreviation (for example, EA, OZ, IN).

## Section II. EXPENDABLE SUPPLIES AND MATERIALS LIST

(1) ITEM NO.	(2) LEVEL	(3) NATIONAL STOCK NUMBER	(4) DESCRIPTION	(5) U/M
1	C	8305-00-267-3015	Cloth, cheese cloth (81348)	YD
2	C	792-00-178-8315	2 3/4" long bristle brush	EA
3	C	7930-01-055-6121	Detergent, GP, liq.	GL
4	C	6850-00-105-3084	Trichlorotrifluoroethane cleaning compound	OZ

**GLOSSARY**

<b>audio</b> . . . . .	Frequencies that are heard.
<b>associated</b> . . . . .	Closely connected.
<b>auxiliary</b> . . . . .	Any item not directly apart of a specific component or system but required for its functional operation.
<b>coarse tune</b> . . . . .	To tune the signal within a "ballpark" range for fine tuning.
<b>demodulator</b> . . . . .	A device used to convert audio tones into dc mark and space pulses.
<b>intensity</b> . . . . .	A term used to designate brightness or luminance of the spot.
<b>modem</b> . . . . .	Modulator/demodulator.
<b>modulator</b> . . . . .	A device used to convert direct current (dc) mark and space pulses into audio tones.
<b>polarities</b> . . . . .	Having two opposite charges - one positive, one negative.
<b>pony loop circuit</b> . . . . .	Allows teletypewriter order wire transmission and reception over landlines from a remote tion when system is not operating in the dc mode.
<b>remote</b> . . . . .	Control indirectly or from a distance.
<b>single-channel</b> . . . . .	Use of one frequency for transmission and reception.
<b>stabilize</b> . . . . .	To hold steady.



INDEX

SUBJECT	PAGE
A	
Abbreviations . . . . .	1-2
Alternate Method . . . . .	2-19
C	
Circuit Breaker check . . . . .	3-1
Cleaning . . . . .	3-2
Controls, Indicators, and Connectors . . . . .	2-1
Current Checks	
DC LOOP NO. 1 . . . . .	2-14
DC LOOP NO. 2 . . . . .	2-20
D	
Data, Performance . . . . .	1-4
DC LOOP NO. 1	
Current Check . . . . .	2-14
DC LOOP NO. 2	
Current Check . . . . .	2-20
Description and Use of Operator's Controls, Indicators, and Connectors . . . . .	2-1
Description of the MD-522A/GRC . . . . .	1-3
Duplex Operation . . . . .	2-20
E	
Equipment Data . . . . .	1-4
Equipment Description . . . . .	1-3
Equipment Purpose, Capabilities and Features . . . . .	1-3
F	
Forms, Maintenance . . . . .	1-1
I	
Inspection, Routine . . . . .	3-2
Instructions, Operating . . . . .	2-13

INDEX - Continued

SUBJECT	PAGE
<b>M</b>	
Maintenance	
Forms . . . . .	1-1
Instructions . . . . .	3-0
Procedures . . . . .	3-2
MD-522A/GRC, description . . . . .	1-3
<b>N</b>	
Nomenclature, Cross	
Reference . . . . .	1-3
<b>O</b>	
Operating Instructions . . . . .	2-0
Operation	
Duplex . . . . .	2-20
One Way Reversible . . . . .	2-13
Pony Circuit . . . . .	2-21
Remote . . . . .	2-21
Operation Under Usual	
Conditions . . . . .	2-12
Operation Under Unusual	
Conditions . . . . .	2-22
<b>P</b>	
Performance Data . . . . .	1-4
Preferred Method . . . . .	2-18
Preparation for use . . . . .	2-12
Preventive Maintenance	
(PMCS) . . . . .	2-8
Pony Circuit Operation . . . . .	2-21
Power, Turn On . . . . .	2-8
Purpose, Capabilities and	
Features . . . . .	1-3
<b>R</b>	
Reception, Teletypewriter . . . . .	2-17
Reception, Voice . . . . .	2-16
Records, Maintenance . . . . .	1-1
Remote Operation . . . . .	2-22
Reports, Equipment	
Improvement	
Recommendations . . . . .	1-3
Routine Inspection . . . . .	3-2
Routine Services . . . . .	2-8

INDEX - Continued

SUBJECT	PAGE
<b>S</b>	
Simplified Block Diagram	
Description . . . . .	1-5
Start Procedures . . . . .	2-13
Stop Procedures . . . . .	2-22
<b>T</b>	
Teletypewriter	
Transmission . . . . .	2-15
Reception . . . . .	2-17
Troubleshooting	
Procedures . . . . .	3-1
Table . . . . .	3-1
Tuning	
Alternate . . . . .	2-19
Preferred . . . . .	2-18
Types of Operation . . . . .	2-12
<b>U</b>	
Unusual Conditions, Operation . . . . .	2-12
Unusual Conditions, Operation . . . . .	2-22
<b>V</b>	
Voice	
Transmission . . . . .	2-15
Reception . . . . .	2-16
<b>W</b>	
Weights and Dimensions . . . . .	1-4





RECOMMENDED CHANGES TO EQUIPMENT TECHNICAL PUBLICATIONS



THEN JOT DOWN THE DOPE ABOUT IT ON THIS FORM CAREFULLY TEAR IT OUT FOLD IT AND DROP IT IN THE MAIL

SOMETHING WRONG WITH THIS PUBLICATION?

FROM (PRINT YOUR UNIT'S COMPLETE ADDRESS)  
 Commander  
 Stateside Army Depot  
 ATTN: AMSTA-US  
 Stateside, N.J. 07705

DATE SENT 10 July 1975

PUBLICATION NUMBER  
 TM 11-5840-340-12

PUBLICATION DATE  
 23 Jan 74

PUBLICATION TITLE  
 Radar Set AN/PRC-76

BE EXACT PIN-POINT WHERE IT IS

PAGE NO	PARA GRAPH	FIGURE NO	TABLE NO
2-25	2-28		
3-10	3-5	3-1	
5-6	5-8		

IN THIS SPACE TELL WHAT IS WRONG AND WHAT SHOULD BE DONE ABOUT IT:

Recommend that the installation antenna alignment procedure be changed throughout to specify a 2<sup>o</sup> IFF antenna lag rather than 1<sup>o</sup>.

REASON: Experience has shown that with only a 1<sup>o</sup> lag, the antenna servo system is too sensitive to wind gusting in excess of 25 knots, and has a tendency to rapidly accelerate and decelerate as it hunts, causing strain to the drive train. Hunting is minimized by adjusting the lag to 2<sup>o</sup> without degradation of operation.

Item 5, Function column. Change "2 db" to "3db."

REASON: The adjustment procedure the the TRANS POWER FAULT indicator calls for a 3 db (500 watts) adjustment to light the TRANS POWER FAULT indicator.

Add new step f.1 to read, "Replace cover plate removed in step e.1, above."

REASON: To replace the cover plate.

Zone C 3. On J1-2, change "+24 VDC to "+5 VDC."

REASON: This is the output line of the 5 VDC power supply. +24 VDC is the input voltage.

PRINTED NAME GRADE OR TITLE AND TELEPHONE NUMBER  
 SSG I. M. DeSpirito 999-1776

SIGN HERE

DA FORM 2028-2 JUL 79

PREVIOUS EDITIONS ARE OBSOLETE

IF YOUR UNIT WANTS TO KNOW ABOUT YOUR RECOMMENDATION MAKE A CARBON COPY OF THIS AND GIVE IT TO YOUR HEADQUARTERS

FILL IN YOUR  
UNIT'S ADDRESS

FOLD BACK

TEAR ALONG PERFORATED LINE

DEPARTMENT OF THE ARMY

OFFICIAL BUSINESS

**SAMPLE**

Commander  
US Army Communications-Electronics Command  
and Fort Monmouth  
ATTN: DRSEL-ME-MP  
Fort Monmouth, New Jersey 07703

RECOMMENDED CHANGES TO EQUIPMENT TECHNICAL PUBLICATIONS



THEN...JOT DOWN THE DOPE ABOUT IT ON THIS FORM. CAREFULLY TEAR IT OUT, FOLD IT AND DROP IT IN THE MAIL.

**SOMETHING WRONG** WITH THIS PUBLICATION?

FROM: (PRINT YOUR UNIT'S COMPLETE ADDRESS)

DATE SENT

PUBLICATION NUMBER

**TM 11-5805-387-10-2**

PUBLICATION DATE

**5 APRIL 1984**

PUBLICATION TITLE

**MODEM RADIO  
TELETYPEWRITER MD-522A /GRC**

BE EXACT PIN-POINT WHERE IT IS

PAGE NO.	PARA-GRAPH	FIGURE NO.	TABLE NO.

IN THIS SPACE TELL WHAT IS WRONG AND WHAT SHOULD BE DONE ABOUT IT:

TEAR ALONG PERFORATED LINE

PRINTED NAME GRADE OR TITLE AND TELEPHONE NUMBER

SIGN HERE

DA FORM 1 JUL 79 2028-2

PREVIOUS EDITIONS ARE OBSOLETE

P.S.--IF YOUR OUTFIT WANTS TO KNOW ABOUT YOUR RECOMMENDATION MAKE A CARBON COPY OF THIS AND GIVE IT TO YOUR HEADQUARTERS.

FILL IN YOUR  
UNIT'S ADDRESS

FOLD BACK

DEPARTMENT OF THE ARMY

OFFICIAL BUSINESS

Commander  
US Army Communications-  
Electronics Command  
ATTN: DRSEL-ME-MP  
Fort Monmouth, New Jersey 07703

FOLD BACK

TEAR ALONG DOTTED LINE

RECOMMENDED CHANGES TO EQUIPMENT TECHNICAL PUBLICATIONS



THEN...JOT DOWN THE DOPE ABOUT IT ON THIS FORM. CAREFULLY TEAR IT OUT, FOLD IT AND DROP IT IN THE MAIL.

**SOMETHING WRONG** WITH THIS PUBLICATION?

FROM: (PRINT YOUR UNIT'S COMPLETE ADDRESS)

DATE SENT

PUBLICATION NUMBER <b>TM 11-5805-387-10-2</b>	PUBLICATION DATE <b>5 APRIL 1984</b>	PUBLICATION TITLE <b>MODEM RADIO TELETYPEWRITER MD-522A /GRC</b>
--	---	---

BE EXACT PIN-POINT WHERE IT IS

PAGE NO.	PARA-GRAPH	FIGURE NO.	TABLE NO.

IN THIS SPACE TELL WHAT IS WRONG AND WHAT SHOULD BE DONE ABOUT IT:

PRINTED NAME GRADE OR TITLE AND TELEPHONE NUMBER

SIGN HERE

TEAR ALONG PERFORATED LINE

DA FORM 2028-2  
1 JUL 79

PREVIOUS EDITIONS ARE OBSOLETE

P.S.--IF YOUR OUTFIT WANTS TO KNOW ABOUT YOUR RECOMMENDATION MAKE A CARBON COPY OF THIS AND GIVE IT TO YOUR HEADQUARTERS.

FILL IN YOUR  
UNIT'S ADDRESS

FOLD BACK

DEPARTMENT OF THE ARMY

OFFICIAL BUSINESS

Commander  
US Army Communications-  
Electronics Command  
ATTN: DRSEL-ME-MP  
Fort Monmouth, New Jersey 07703

FOLD BACK

RECOMMENDED CHANGES TO EQUIPMENT TECHNICAL PUBLICATIONS



THEN...JOT DOWN THE DOPE ABOUT IT ON THIS FORM. CAREFULLY TEAR IT OUT, FOLD IT AND DROP IT IN THE MAIL.

**SOMETHING WRONG** WITH THIS PUBLICATION?

FROM: (PRINT YOUR UNIT'S COMPLETE ADDRESS)

DATE SENT

PUBLICATION NUMBER  
**TM 11-5805-387-10-2**

PUBLICATION DATE  
**5 APRIL 1984**

PUBLICATION TITLE  
**MODEM RADIO  
TELETYPEWRITER MD-522A /GRC**

BE EXACT PIN-POINT WHERE IT IS

PAGE NO.	PARA. GRAPH	FIGURE NO.	TABLE NO.

IN THIS SPACE TELL WHAT IS WRONG AND WHAT SHOULD BE DONE ABOUT IT:

TEAR ALONG PERFORATED LINE

PRINTED NAME GRADE OR TITLE AND TELEPHONE NUMBER

SIGN HERE

DA FORM 2028-2  
JUL 79

PREVIOUS EDITIONS ARE OBSOLETE

P.S.--IF YOUR OUTFIT WANTS TO KNOW ABOUT YOUR RECOMMENDATION MAKE A CARBON COPY OF THIS AND GIVE IT TO YOUR HEADQUARTERS.

FILL IN YOUR  
UNIT'S ADDRESS



FOLD BACK

DEPARTMENT OF THE ARMY

OFFICIAL BUSINESS

Commander  
US Army Communications-  
Electronics Command  
ATTN: DRSEL-ME-MP  
Fort Monmouth, New Jersey 07703

FOLD BACK

TELETYPE ALONG DOTTED LINE



By Order of the Secretary of the Army:

JOHN A. WICKHAM JR.  
*General, United States Army*  
*Chief of Staff*

Official:

ROBERT M. JOYCE  
*Major General, United States Army*  
*The Adjutant General*

DISTRIBUTION :

To be distributed in accordance with DA Form 12-51 requirements  
for MD-522/GRC.

\* U. S. GOVERNMENT PRINTING OFFICE : 1992 0 - 311-831 (61041)





