

ARMY TM 11-5820-489-10 AIR FORCE TO 31R4-2GRA6-31

OPERATOR'S MANUAL

EQUIPMENT
DESCRIPTION
PAGE 1-2

OPERATOR'S
CONTROLS
PAGE 2-1

PMCS
PAGE 2-8

OPERATION
PAGE 2-13

TROUBLE-
SHOOTING
PAGE 3-1

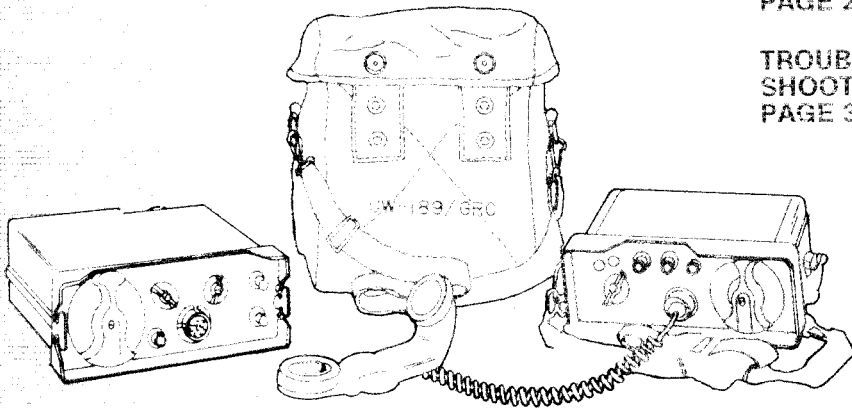

CONTROL GROUP AN/GRA-6 **(NSN 5820-00-644-4554)**

DEPARTMENTS OF THE ARMY AND THE AIR FORCE
23 NOVEMBER 1983



5

SAFETY STEPS TO FOLLOW IF SOMEONE IS THE VICTIM OF ELECTRICAL SHOCK

1

DO NOT TRY TO PULL OR GRAB THE INDIVIDUAL

2

IF POSSIBLE , TURN OFF THE ELECTRICAL POWER

3

IF YOU CANNOT TURN OFF THE ELECTRICAL POWER, PULL, PUSH, OR LIFT THE PERSON TO SAFETY USING A WOODEN POLE OR A ROPE OR SOME OTHER INSULATING MATERIAL

4

SEND FOR HELP AS SOON AS POSSIBLE

5

AFTER THE INJURED PERSON IS FREE OF CONTACT WITH THE SOURCE OF ELECTRICAL SHOCK, MOVE THE PERSON A SHORT DISTANCE AWAY AND IMMEDIATELY START ARTIFICIAL RESUSCITATION



HIGH VOLTAGE

is used in the operation of this equipment.

DEATH ON CONTACT

may occur if person operating this equipment fails to obey safety precautions.

Do not be misled by The Term LOW VOLTAGE. Voltage as low as 90 volts may cause DEATH under certain conditions.

TRICHLOROTRIFLUOROETHANE

Adequate ventilation should be provided while using TRICHLOROTRIFLUOROETHANE. Prolonged breathing of vapor should be avoided. The solvent should not be used near heat or open flame; the products of decomposition are toxic and irritating. Since TRICHLOROTRIFLUOROETHANE dissolves natural oils, prolonged contact with skin should be avoided. When necessary, use gloves which the solvent cannot penetrate. If the solvent is taken internally, consult a physician immediately.

OPERATOR'S MANUAL
CONTROL GROUP AN/GRA-6
(NSN 5820-00-644-4554)

REPORTING ERRORS AND RECOMMENDING IMPROVEMENTS

You can help improve this manual. If you find any mistakes or if you know of a way to improve the procedures, please let us know. Mail your letter or DA Form 2028 (Recommended Changes to Publications and Blank Forms), direct to: Commander, US Army Communications-Electronics Command and Fort Monmouth, ATTN: DRSEL-ME-MP, Fort Monmouth, New Jersey 07703.

For Air Force, submit AFTO Form 22 (Technical Order System Publication Improvement Report and Reply) in accordance with paragraph 6-5, Section VI, TO 00-5-1. Forward direct to prime ALC/MST.

In either case, a reply will be furnished direct to you.

TABLE OF CONTENTS

	PAGE
HOW TO USE THIS MANUAL	iii
CHAPTER 1 INTRODUCTION	1-0
Section I General Information	1-1
Scope	1-1
Maintenance Forms, Records and Reports.	1-1
Reporting Equipment Improvement	
Recommendations (EIR)	1-1
Nomenclature Cross-Reference List	1-1
List of Abbreviations	1-2
Hand Receipt	1-2
II Equipment Description	1-2
Purpose, Capabilities and Features	1-2
Description of Major Components	1-3
Differences Between Models	1-6
Performance Data	1-6
III Technical Principles of Operation.	1-8
Arrangement of Local Control to Remote Control	1-8

*This manual supersedes so much of TM 11-5038, 18 April 1951, including all changes as pertains to operator maintenance.

TABLE OF CONTENTS - Continued

PAGE

CHAPTER 2	OPERATING INSTRUCTIONS	2 - 0
Section I	Description and use of Operator's Controls and Indicators	2 - 1
	Panel Controls and Facilities	2 - 1
Section II	Preventive Maintenance Checks and Services	2 - 8
	General	2 - 8
	Preventive Maintenance Checks and Services Procedures	2 - 8
Section III	Operation Under Usual Conditions	2-13
	Assembly and Preparation for Use	2-13
	Initial Adjustments, Daily Checks and Self- Test	2-24
	Operating Procedure	2-27
Section IV	Operation Under Unusual Conditions	2-38
	General	2-38
	Operation in Arctic Climates	2-38
	Operation in Tropical Climates	2-38
	Operation in Desert Climates.	2-38
CHAPTER 3	MAINTENANCE INSTRUCTIONS	3 - 0
Section I	Troubleshooting	3 - 1
	Troubleshooting Information	3 - 1
Section II	Maintenance Procedures	3 - 1
	Introduction	3 - 1
	Inspection	3 - 1
	Removal and Replacement.	3 - 3
	Cleaning	3 - 4
APPENDIX A	REFERENCES	A-1
B	COMPONENTS OF END ITEM AND BASIC ISSUE ITEMS LISTS	B-1
Section I	Introduction	B-1
II	Componentsof End Item	B-2
III	Basic Issue Items	B-3
APPENDIX C	ADDITIONAL AUTHORIZATION LIST	C-1
Section I	Introduction	C-1
II	Additional Authorization List	C-1
APPENDIX D	EXPENDABLE SUPPLIES AND MATERIALS LIST	D-1
Section I	Introduction	D-1
II	Expendable Supplies and Materials List	D-2

HOW TO USE THIS MANUAL

- THIS MANUAL TELLS ABOUT THE TYPICAL ARRANGEMENTS OF CONTROL GROUP AN/GRA-6.
- ALL THE PROCEDURES IN THIS MANUAL MUST BE EXAMINED BEFORE YOU BEGIN ANY TASK.
- THROUGHOUT THIS MANUAL COLOR CODED MARGIN TABS WILL GUIDE YOU TO THE SECTION THAT CONTAINS THE SPECIFIC INFORMATION YOU NEED.
- THIS MANUAL IS ORGANIZED INTO CHAPTERS, SECTIONS, PARAGRAPHS AND ILLUSTRATIONS, WHICH ARE NUMBERED TO HELP YOU FIND INFORMATION ABOUT YOUR EQUIPMENT QUICKLY AND EASILY.
- COLOR IS USED TO EMPHASIZE KEY POINTS.
- UNFAMILIAR WORDS WILL BE EXPLAINED AT THE BEGINNING OF EACH CHAPTER.
- THE SUBJECT INDEX IN THE BACK OF THE MANUAL WILL HELP YOU FIND INFORMATION QUICKLY.

CHAPTER 1
INTRODUCTION

Abbreviations1-2
Arrangement of Local Control to RemoteControl 1-8
Differences between Models1-6
Hand Receipt1-2
Maintenance Forms, Records and Reports1-1
MajorComponents1-3
Nomenclature Cross-Reference1-1
Performance Data1-6
Purpose, Capabilities, and Features1-2
Reporting Equipment Improvement Recommendations 1-1
Scope1-1

HANDSET H-33/PT

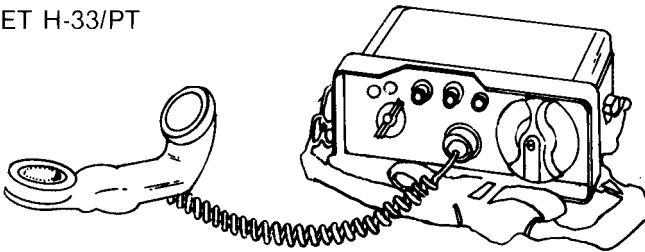

REMOTE CONTROL C-433/GRC

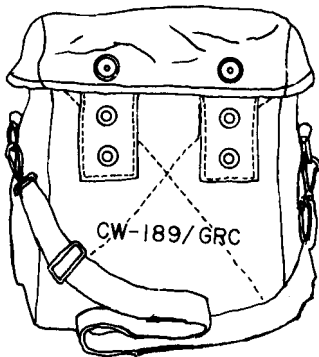

BAG CW-189/GRC

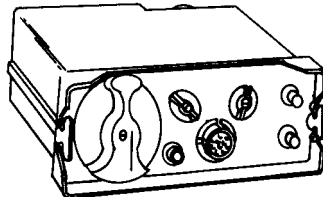

LOCAL CONTROL C-434/GRC

INTRODUCTION

Section I. GENERAL INFORMATION

1-1. SCOPE

This manual describes Control Group AN/GRA-6. The manual covers the operation and Operator's maintenance procedures.

1-2. MAINTENANCE FORMS AND RECORDS

Department of the Army forms and procedures used for equipment maintenance will be those prescribed by TM 38-750, The Army Maintenance Management System (TAMMS).

1-3. REPORTING EQUIPMENT IMPROVEMENT RECOMMENDATIONS (EIR)

a. Army. If your AN/GRA-6 needs improvement, let us know. Send us an EIR. You, the user are the only one who can tell us what you don't like about your equipment. Let us know why you don't like the design. Put it on an SF 368 (Quality Deficiency Report). Mail it to Commander, US Army Communications-Electronics Command and Fort Monmouth, ATTN: DRSEL-ME-MP, Fort Monmouth, New Jersey 07703. We'll send you a reply.

b. Air Force. Air Force personnel are encouraged to submit EIR's in accordance with AFR 900-4.

1-4. NOMENCLATURE CROSS-REFERENCE LIST

Common names will be used when the major components of the Control Group are mentioned in this manual.

COMMON NAME	NOMENCLATURE
Control Group	Control Group AN/GRA-6
Local Control	Local Control C-434/GRC
Remote Control	Remote Control C-433/GRC
Handset	Handset H-33/PT
Bag	Bag CW-189/GRC
Wire	Wire WD-1/TT
Mounting	Mounting MT-297/GR or Mounting MT-298/GR
Interconnecting Box	Interconnecting Box J-654/G
Loudspeaker	Loudspeaker, Dynamic LS-166/U
Battery	Battery, Dry BA-30 or Battery, Dry BA-414/U
Container	Container for Interconnecting BOX J-654/G
Generator	Generator G-25/PT
Multimeter.	Multimeter AN/URM-105

NOTE

Nomenclature **MUST** be used when filling out report forms or looking up Technical Manuals.

1-5. LIST OF ABBREVIATIONS

Abbreviations are spelled out the first time they appear in this manual. A complete list of abbreviations used in this manual is given below.

AAL	Additional Authorization List
ac	alternating current
BII	Basic Issue Items
COEI	Components of End Item
dc	direct current
FSCM	Federal Supply Code of Manufacturer
Hz.	Hertz
o/a	Overall
PMCS	Preventive Maintenance Checks and Services
rpm.	revolutions per minute
u/m	unit of measure

1-6. HAND RECEIPT

This manual has a companion document with a TM number followed by "-HR" (which stands for Hand Receipt). TM 11-5820-489-10-HR consists of preprinted hand receipts (DA Form 2062) that list end item related equipment (i.e., COEI, BII, and AAL) you must account for. As an aid to property accountability, additional -HR manuals may be requisitioned from The US Army Adjutant General Publications Center, Baltimore, MD, in accordance with the procedures in Chapter 3, AR 310-2, and DA PAM 310-10-2.

Section II. EQUIPMENT DESCRIPTION

1-7. PURPOSE, CAPABILITIES AND FEATURES

- Used to control and operate a radio set
- For listening and talking, can use one or two receiver-transmitters, amplifiers or similar push-to-talk types of equipment
- Transmission range about 2 miles (300 to 4000 Hz frequency)
- Small, portable, lightweight, fungi proof
- Continuous dc circuit
- Two-way telephone communication with ringing
- Uses two-wire telephone line
- Can be used under bad weather conditions
- Auxiliary components:
 - Push-to-talk type handset
 - Interconnecting Box
 - 1 set running spares
 - large waterproof carrying bag

1-8. DESCRIPTION OF MAJOR COMPONENTS

a. Control Group AN/GRA-6

- | | | |
|---|----------------------|---|
| ① | Local Control | Permits local selection of telephone operation or push-to-talk operation. |
| ② | Remote Control | Permits field telephone operation connections with local control up to a 2 mile range |
| ③ | Handsets | Used for transmitting and receiving voice signals. |
| ④ | Bag | Used to contain Control Units, Handset, and running spare parts when not in use. |
| ⑤ | Carrying strap | For use in carrying Remote Control Unit. |
| ⑥ | Interconnecting Box | Used when Handset and Loudspeaker are needed at the same time. |

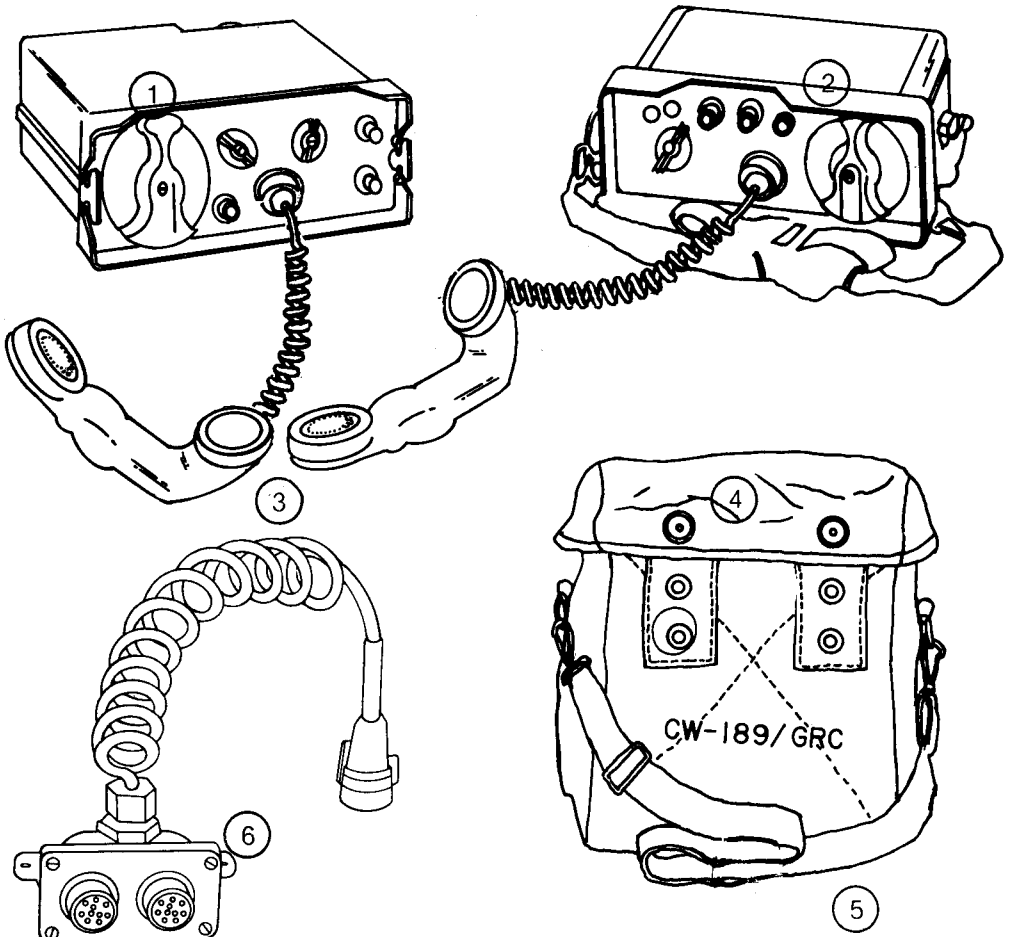

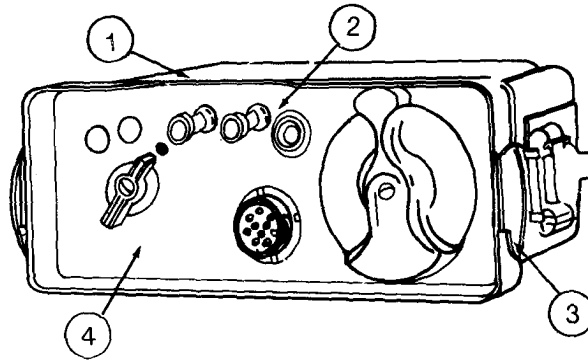

b. Remote Control

- ① Outer Case Waterproof, houses panel and chassis.
- ② Battery Compartment Cover (under case) Provides access to area that contains batteries.
- ③ "D" rings These hold shoulder strap for carrying position. In carrying position, operating controls of front panel face upward.
- ④ Front Panel Contains controls and instruments for operation.

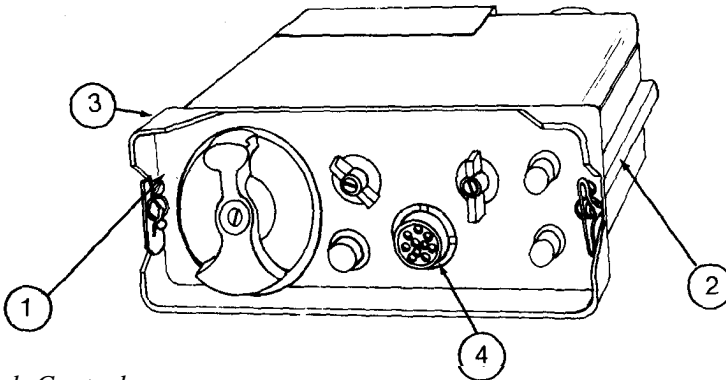

c. Local Control

- ① Front Panel Contains controls and instruments for operation.
- ② Channel or Mounting runners Allows Local Control to be mounted for plug-in connection to radio sets using mounting.
- ③ Outer Case Waterproof, houses panel and chassis.
- ④ Connector Plugs into a mating connector on a mounting radio set to establish an electrical connection between Control Unit and radio set (see rear view).

Local Control, Rear View

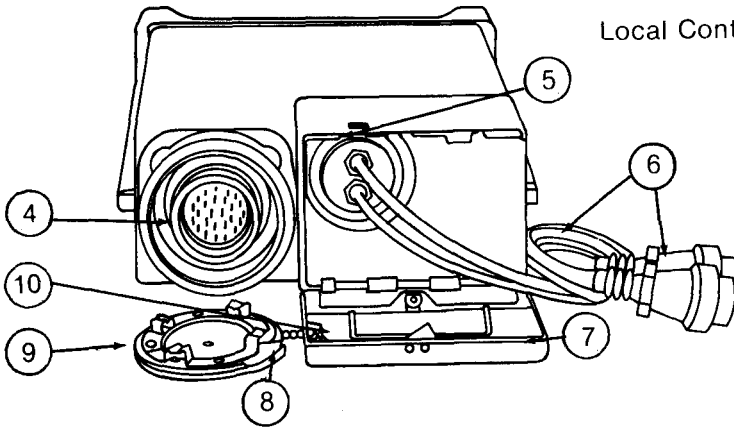

- | | | |
|------|-------------------------------|--|
| (5) | Cable Compartment Cover Latch | A means to control opening and closing of cable compartment cover. |
| (6) | Cable Assembly | Means for establishing electrical connections between Control Unit and radio sets. |
| (7) | Cable Compartment Cover | Provides access to area that contains cable assembly. |
| (8) | Cap Retainer Chain | An aid to preventing loss of cap. |
| (9) | Cap | Used for the protection of connector plug when not in use. |
| (10) | Cap Retaining Bracket | Used to hold the cap when the connector is being used. |

d. Handset

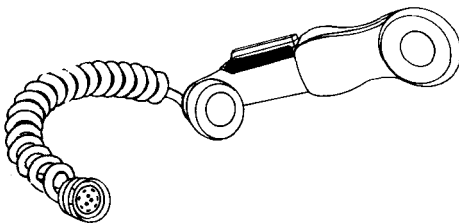

Push-to-talk switch is used to provide voice communication. Push switch to talk and release switch to listen.

e. Interconnecting box

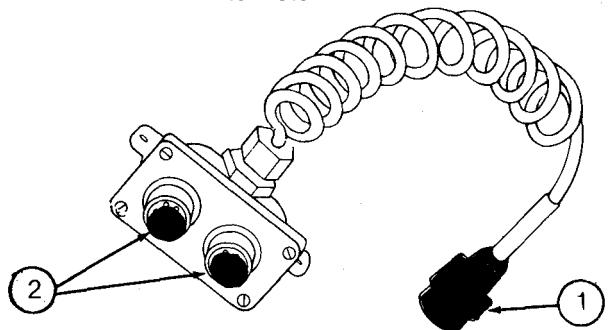

- | | | |
|-----|-----------------------|---|
| (1) | Plug Connector | When plugged into Remote Control, provides extra electrical power to extension. |
| (2) | Receptacle Connectors | Needed when Loudspeaker and Handset are used at the same time. |

1-9. DIFFERENCES BETWEEN MODELS

Generators	G-25/PT (used in this manual)	G-25A/PT (others)
	rotates at 155 rpm.	rotates at 208 rpm

1-10. PERFORMANCE DATA

ITEMS USED IN AN OPERABLE CONTROL GROUP

Item No.	Qty.	Component	Power Requirements	Technical Characteristics
1	1	Remote Control C-433/GRC	80 to 100v ac, 20 Hz single ph battery 3v + 45v dc.	manual control, alumn, 7lbs, (3.15 kg) 9-3/8" I X : 3 1/2" h X 7" w
2	1	Local Control C-434/GRC	80 to 100v ac, 20 Hz single ph dc battery power, 3v.	manual control, alumn, 10 1/2 lbs., (5.6 kg) 8-9/16" I X 10 1/2" w X 3 1/2" h
3	2	Handset H-33/PT	300 ohms impedance, 100 Hz, carbon type xmtr 40 ohms dc resistance, 60 ma 300 to 4000 Hz freq. range.	battery powered, black plastic handle, magnetic receiver 1-1/8lbs. (.51 kg)
4	1	Interconnecting Box J-654/G		3/8" dia. cable accom, alumn w/cover, 1 lb. (.45 kg) 4-5/8" lg X 2-1/8" w X 1 1/4" h (incl. 3 ft. interconnection cord)
5	1	Container for Interconnecting Box J-654/G		2lbs. (.9 kg) X 0.2 cu ft.
6	1	Loudspeaker, Dynamic LS-166/U	8 ohms voice call impedance, 2w normal and 3w peak input	5-21/32 " I X 3-3/16" w X 7-1/32 " h
7	4	Battery, dry BA-30	1.5V	(2 ea. local control) (2 ea. remote control)
8	1	Battery, dry BA-414/U	45v tapped at 22v	used with remote control

ITEMS USED IN AN OPERABLE CONTROL GROUP - Continued

Item No.	Qty.	Component	Power Requirements	Technical Characteristics
9	1	Lamp, glow	1/25w, 65v, ac, 90v dc	neon gas, GE type NE51 (used with local control) 1-1/8" h o/a
10	1	Lamp, glow	1/25w, 65v, ac, 90v dc	neon gas GE NE-51 (used with remote control). 1-1/8" h o/a

NOTE

Dry batteries shown are used with the equipment, but are not considered part of the equipment. They will not be preshipped automatically, but are to be requisitioned in quantities necessary for the particular organization in accordance with SB 11-6.

Section III. TECHNICAL PRINCIPLES OF OPERATION

1-11. ARRANGEMENT OF LOCAL CONTROL TO REMOTE CONTROL

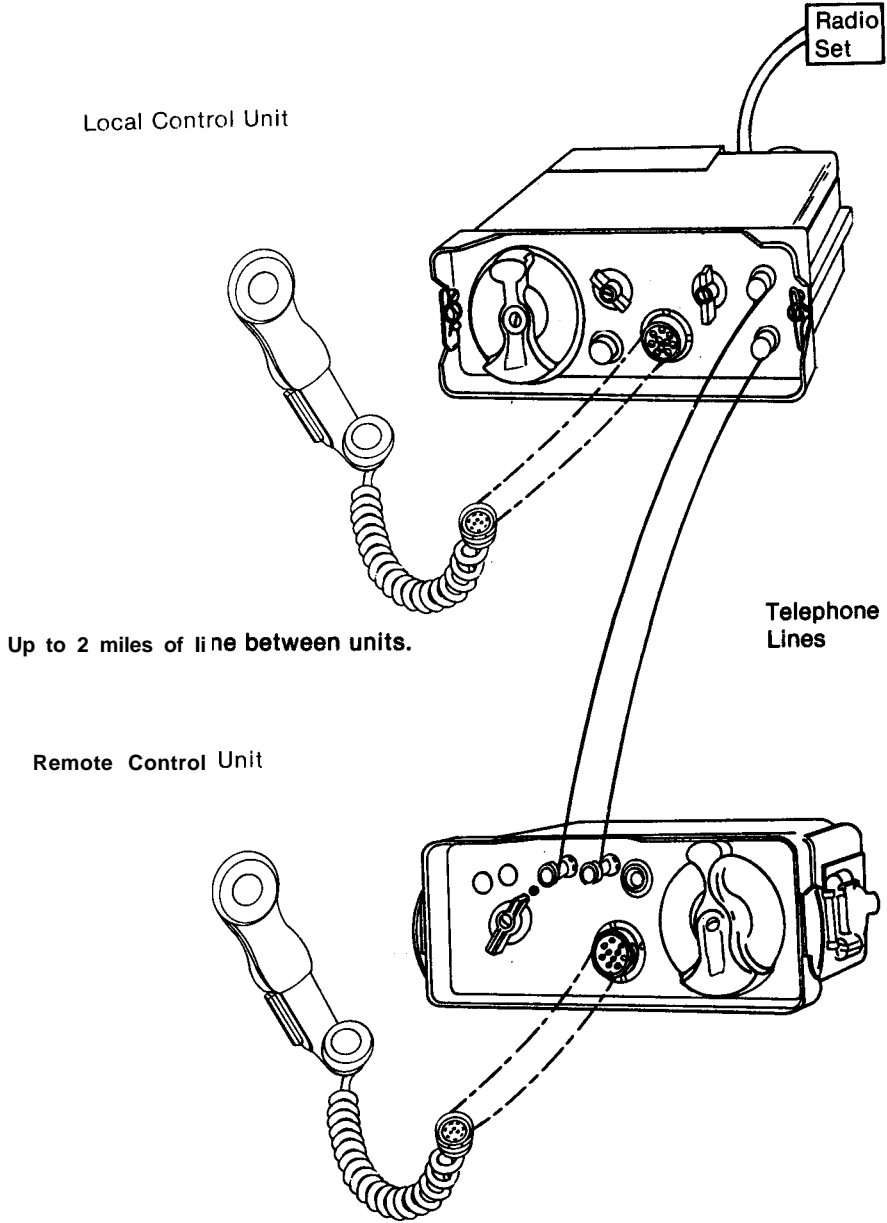

CHAPTER 2
OPERATING INSTRUCTIONS

	PAGE
Controls and Indicators	2-1
Local Unit	2-1
Remote Unit	2-5
Initial adjustment	2-24
Telephone circuits	2-24
Telephone lines	2-23
Write-in blanks	2-25
Assembly and Preparation for Use	2-13
Accessories	2-23
Local Control Unit	2-17
Remote Control Unit	2-13
Operating Procedure	2-27
Break-in	2-34
Local push-to-talk	2-33
Monitoring	2-33
Remote push-to-talk	2-31
Ringing	2-28
Stopping	2-37
Operation - Unusual conditions.	2-38
Arctic Climates	2-38
Desert Climates	2-38
Tropical Climates	2-38
Preventive Maintenance	2-8

Section I. DESCRIPTION AND USE OF OPERATOR'S CONTROLS AND INDICATORS

2-1. PANEL CONTROLS AND FACILITIES

a. Local Control Panel controls and indicators.

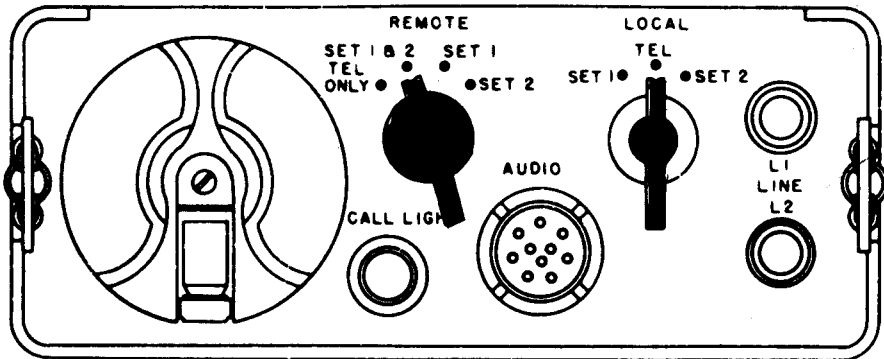

Local Switch

**POSITION
of Control or
Indicators**

**FUNCTION
when used with Local
Control Unit**

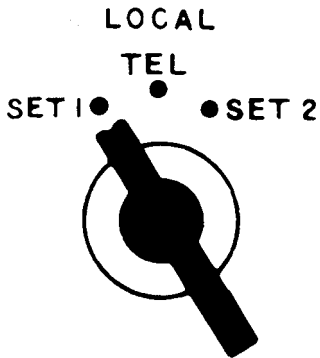

- Allows push-to-talk operation of Set 1 (using spring action).

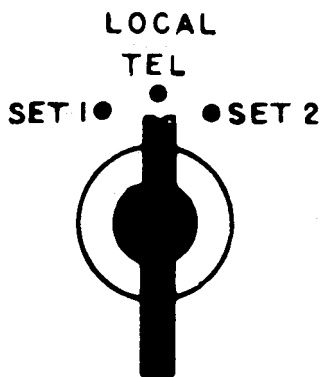

- Allows Telephone operation with Remote Control.

FUNCTION



- Allows push-to-talk operation of Set 2 (using spring action).

Remote Switch

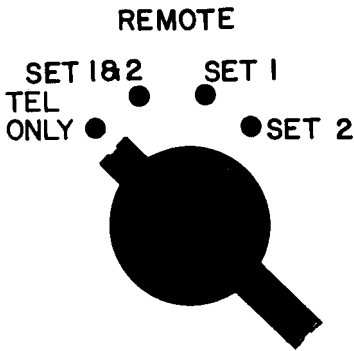

- Allows Telephone communication between Local and Remote Control Units.
- May also be used to turn power OFF in TEL ONLY position.

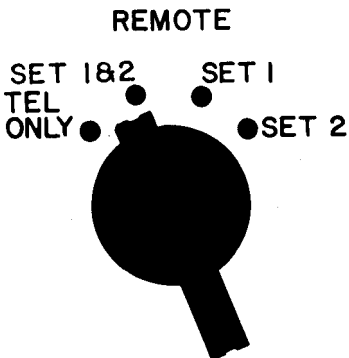

- For push-to-talk operation of either Set 1 or Set 2 move REMOTE knob to Set 1 and Set 2 setting. Local Control is now ON.

POSITION

FUNCTION

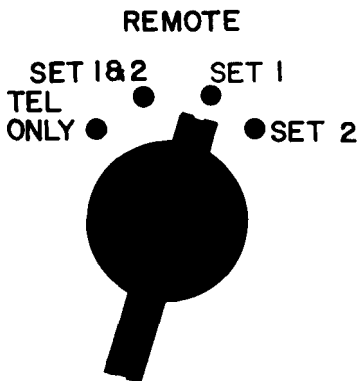

- Provides for Remote Control of power for a radio set and push-to-talk operation of Set 1.
- Monitors Set 1 and Set 2.

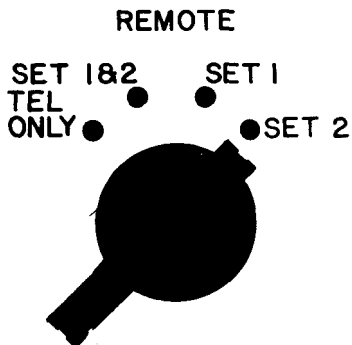

- Provides for Remote Control of power for a radio set and push-to-talk operation of Set 2.
- Monitors Set 1 and Set 2.

Wire Binding Posts

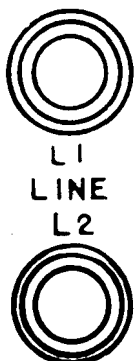

- Allows connection of lines for remote control.

NOTE

To prevent accidental operation of the radio set transmitters, the REMOTE switch of Local Control **MUST** be in the TEL ONLY position when ringing generator is operated.

Ringing Generator

POSITION

FUNCTION

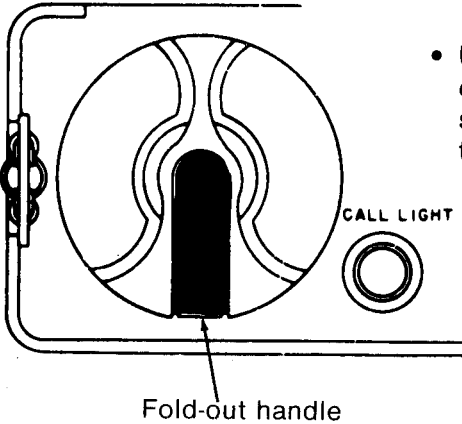

- Using spinner handle and turning clockwise, provides the means of sending a 20-cycle ringing signal to the Remote Control Unit.

Call Light

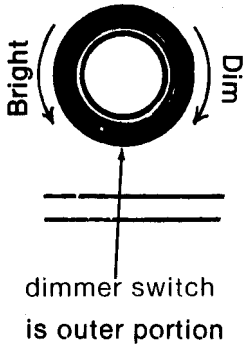

- When lit, shows that a ringing signal is being received from the Remote Control Unit.

- Using dimmer, call light can be adjusted to desired brightness.

- Turn clockwise to dim, counterclockwise to brighten.

Audio Connector

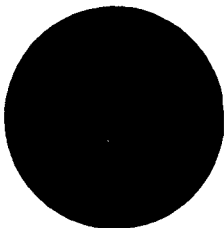

- Connection point for a Handset or similar accessory for telephone communication and push-to-talk operation of the radio set.

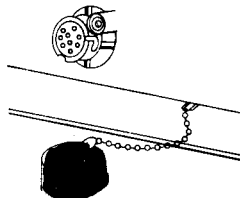

NOTE

Use audio cover when not in operation.

b. Remote Control Panel controls and indicators.

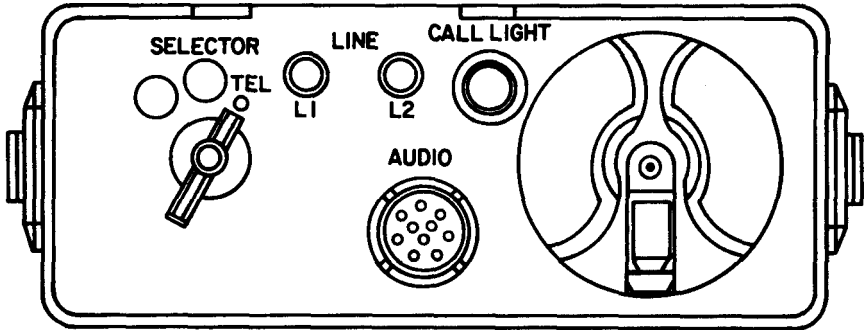

Selector Switch

**POSITION
of Control or
Indicators**

**FUNCTION
when used with Local Control
Unit**

SELECTOR

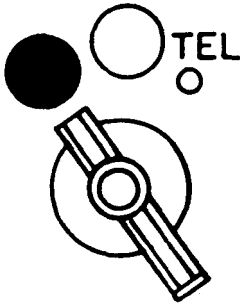

- Provides power ON position for a radio set and/or Set 1 or Set 2 depending on indicator setting at Local Control Unit.

**Write-in positions (spaces) for operator
to record functions of switch positions.**

SELECTOR

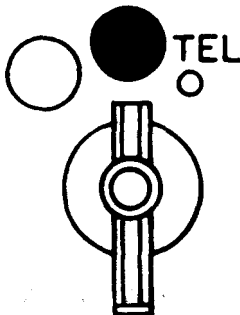

- Provides power OFF position for a radio set and/or Set 1 or Set 2 depending on indicator setting at Local Control Unit.

NOTE

The functions of the write-in positions will be reversed if the telephone line connections are reversed at either Local or Control units.

**POSITION
of Control or
Indicator**

**FUNCTION
when used with Local Control
Unit**

SELECTOR

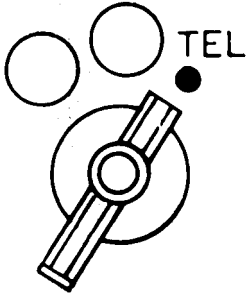

- For telephone communications with Local Control Unit.

Wire Bind Posts

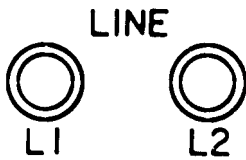

- Allows connection of Remote Control Unit.

NOTE

To prevent accidental operation of the radio set transmitters, the REMOTE switch of Local Control MUST be in the TEL ONLY position when ringing generator is operated.

Ringing Generator

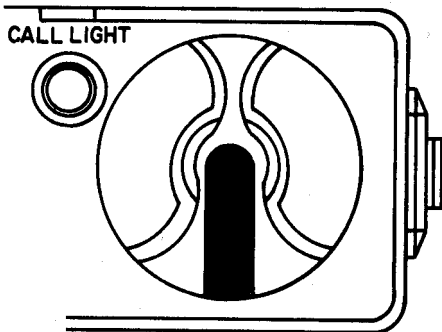

- Using spinner handle and turning clockwise provides the means of sending a 20-cycle ringing signal to the Local Control Unit.

Fold-out handle

**POSITION
of Control or
Indicator**

**FUNCTION
when used with Local Control
Unit**

Call Light

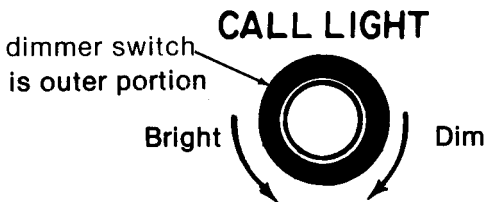

- When lit, shows that a ringing signal is being received at the Local Control Unit.
- Using dimmer, call light can be adjusted to desired brightness.
- Turn clockwise to dim, counterclockwise to brighten.

Audio Connector

AUDIO

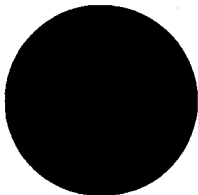

- This is where a Handset or similar accessory for telephone communication and push-to-talk operation of the radio set is connected.

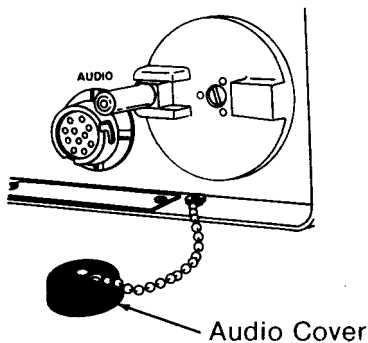

- Use audio cover when not in operation.

Section II. PREVENTIVE MAINTENANCE CHECKS AND SERVICES (PMCS)

2-2. GENERAL

Operator's Preventive Maintenance Checks and Services (PMCS) are the required daily and weekly inspections and care of your equipment necessary to keep it in good operating condition.

Tools and Materials

No tools or equipment are required for operator maintenance. The following cleaning materials will be useful to you:

- Lint-free cloths
- Soft bristle brush
- Dishwashing compound or detergent
- Cleaning compound

2-3. PREVENTIVE MAINTENANCE CHECKS AND SERVICES PROCEDURES

NOTE

If your Control Group AN/GRA-6 must be in USE ALL THE TIME, check and service those items that can be checked and serviced without stopping its operation. Make COMPLETE checks and services ONLY when the Control Group is finally SHUT DOWN.

a. Routine Services

Routine services are not listed in the PMCS table. They are, however, important and should be done on a routine basis. Here are the routine steps to be performed by you as necessary:

- Clean
- Dust
- Wash
- Check for cut or frayed cables
- Check for dented, bent, or broken components
- Check to see that items not in use are properly stored
- Check for rusting
- Check controls for smooth operation
- Cover unused receptacles
- Check for loose nuts, bolts, and connectors
- Check for completeness and current changes to publications

b. Explanation of INTERVAL column of PMCS chart

NOTE

Always keep in mind all CAUTIONS and WARNINGS when PMCS are performed.

WEEKLY - Do your Weekly (W) PMCS to ensure that the Control Group is functioning properly.

NOTE

ALL PMCS must be done as regularly scheduled and also under the following conditions:

- Before the Control Group is used on a mission.
- When the Control Group is first installed.
- When the Control Group is reinstalled after being removed for any reason.
- When you are operating the Control Group for the first time.

c. Explanation of EQUIPMENT IS NOT READY/AVAILABLE IF column of PMCS chart.

I This column tells the conditions under which the equipment can not perform the assigned mission requirements.

NOTE

The procedures column in your PMCS chart tells you how to perform the required checks and services. Carefully follow these instructions. If tools are needed or the chart instructions tell you, get organizational maintenance to do the necessary work.

NOTE

If any portion of your Control Group fails to operate, refer to Chapter 3 under Troubleshooting for possible corrective action. Report any malfunctions or failures on the proper DA Form 2404 or refer to TM 38-750.

DA FORM 2404, EQUIPMENT INSPECTION AND MAINTENANCE WORKSHEET.

EQUIPMENT INSPECTION AND MAINTENANCE WORKSHEET							
For use of this form, see TM 38-750; the proponent agency is the Office of the Deputy Chief of Staff for Logistics.							
1. ORGANIZATION 524 Signal Co.				2. NOMENCLATURE AND MODEL Control Group AMGRA-6			
3. REGISTRATION/SERIAL/FSN 1234		4. MILES	5. HOURS	6. ROUNDS FIRED	7. HOT STARTS	8. DATE 1 July 81	9. TYPE INSPECTION PMCS
7. APPLICABLE REFERENCE							
TM NUMBER		TM DATE		TM NUMBER		TM DATE	
11-5820-489-10		15 May 81					
INSTRUCTIONS - Perform each check listed in the TM applicable to the inspection performed. Following the sequence listed in pertinent TM, complete form as follows:							
COLUMN a - Enter TM item number.				COLUMN d - Show corrective action for deficiency or shortcoming listed in Column c.			
COLUMN b - Enter the applicable condition status symbol.				COLUMN e - Individual ascertaining completed corrective action initial in this column.			
COLUMN c - Enter deficiencies and shortcomings.							
ALL INSPECTIONS AND EQUIPMENT CONDITIONS RECORDED ON THIS FORM HAVE BEEN DETERMINED IN ACCORDANCE WITH DIAGNOSTIC PROCEDURES AND STANDARDS IN THE TM CITED HEREON.							
11. SIGNATURE (Person(s) performing inspection)		12. TIME		13. SIGNATURE (Maintenance Supervisor)		14. TIME	
J. Doe		1630		R. Smith		1730	
15. TM ITEM NO.	16. STATUS	17. DEFICIENCIES AND SHORTCOMINGS		18. CORRECTIVE ACTION		19. INITIAL WHEN CORRECTED	
		loose nuts and bolts		tighten - refer to organizational maintenance		JD	

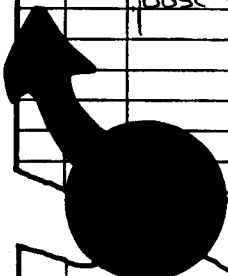

PREVENTIVE MAINTENANCE CHECKS AND SERVICES

W - WEEKLY OPERATION

ITEM NO.		ITEM TO BE INSPECTED	PROCEDURE	EQUIPMENT IS NOT READY/AVAILABLE IF:
1	W	Control Group AN/GRA-6	<p data-bbox="797 409 1093 530">Operate the equipment as described in Section III of Chapter 2 of this manual.</p> <p data-bbox="784 787 860 811">NOTE</p> <p data-bbox="505 820 1142 879">If the equipment has been operated within the last week, weekly requirements have been met.</p>	Equipment cannot be operated. Mission cannot be accomplished.

Section III. OPERATION UNDER USUAL CONDITIONS

2-4. ASSEMBLY AND PREPARATION FOR USE

If received without batteries, follow these procedures:

a. Remote Control Unit

- Set SELECTOR switch to TEL position.



Be careful when opening snap catches.
Avoid injury to your hands!

- Release the two snap catches and slide the unit from the case.

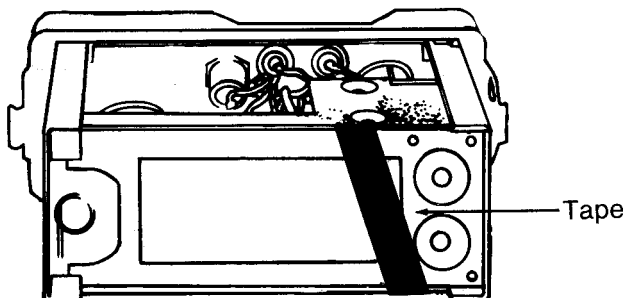
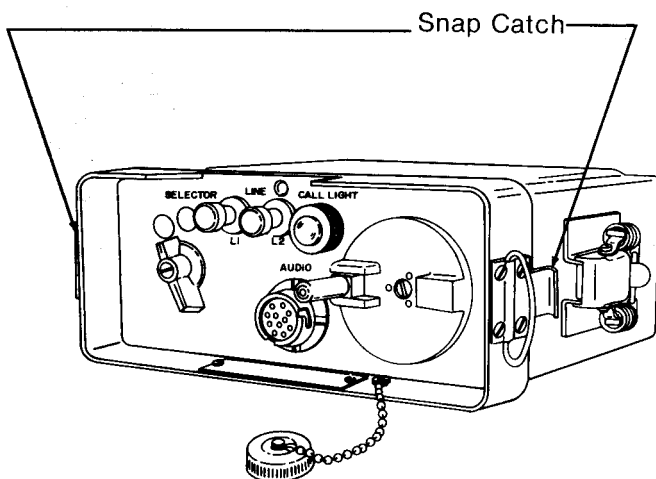

Rear View

- Remove battery cover by sliding to the right to release tabs, then lift off.

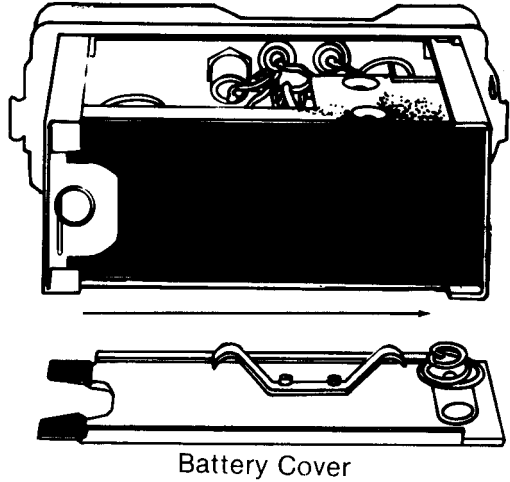

- At rear, install 2 batteries (BA-30) into smaller compartment on right.
- Lay first battery on its side and slide into compartment floor so top portion (positive electrode) enters first and touches the flat contact inside.
- Slide other battery into same area above first battery, so that the flat bottom (negative electrode) enters first and touches spring contact.

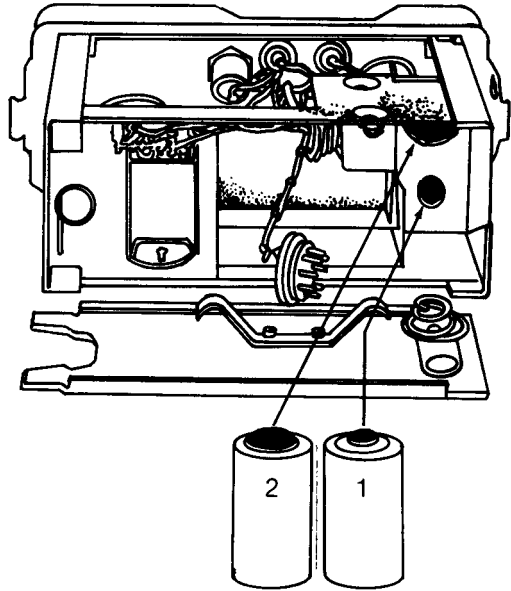

- Insert Battery (BA-414/U) into the larger space, so that the octal socket, faces you.

Insert this end first

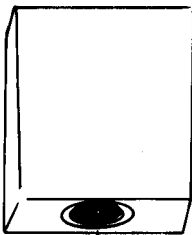

Octal Socket

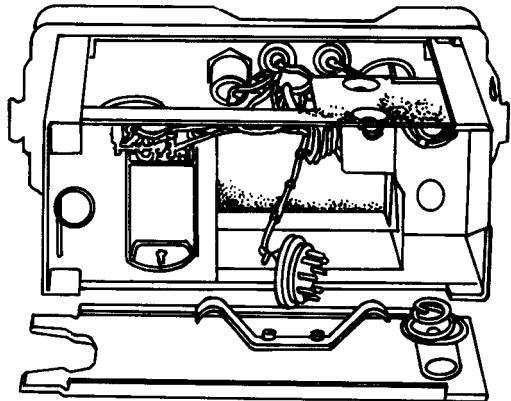

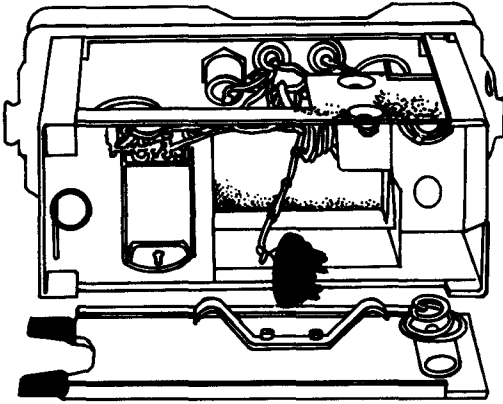

- Align center socket keyway and socket of the battery.

CAUTION

Do not twist.

- Replace battery compartment cover by inserting the two tabs. Press and slide until latch is locked into place.

BELL/LAMP SWITCH

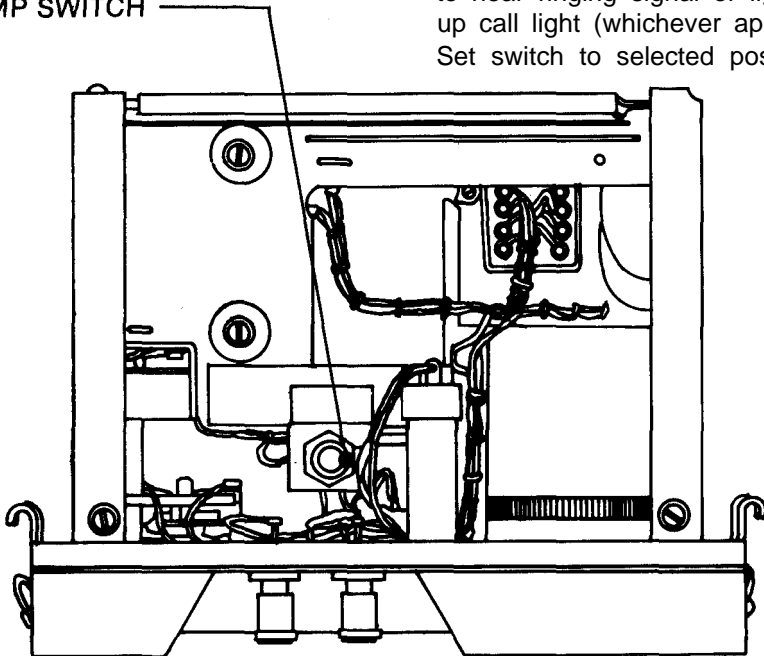

Front (Top View)

- Locate inside Bell/Lamp switch (on top toward front). This is needed to hear ringing signal or light up call light (whichever applies). Set switch to selected position.

- Replace case. Fasten the two snap catches.

- Attach the carrying strap to the two "D" rings located under the snap catches.

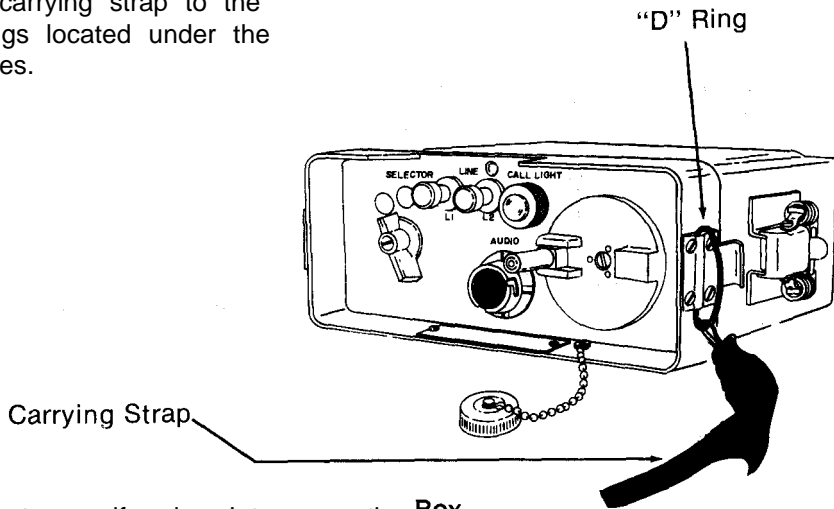

- Remove dustcover if using Interconnecting Box. Then insert plug connector into front panel AUDIO receptacle.

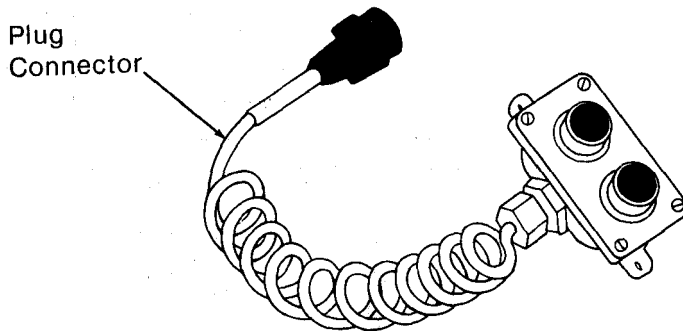

- Plug Handset and Loudspeaker into receptacle connectors for duplex operation. (Send on microphone, receive on speaker).

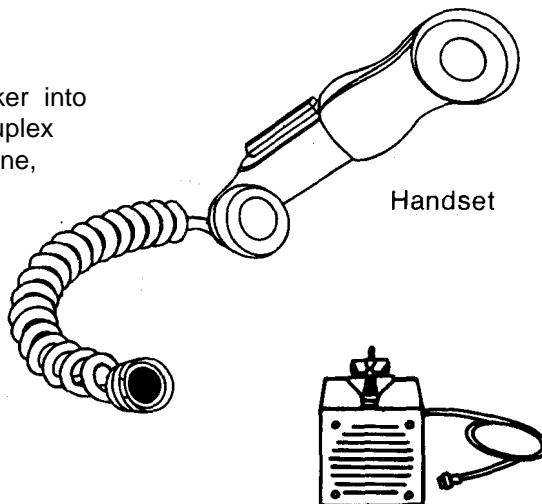

b. Local Control Unit

- To remove unit from case, turn to loosen both thumbscrew fasteners located on the ends of the front panel and slide unit forward.

NOTE

It may be necessary to remove the "O" ring from the power cable connector to remove unit from case.

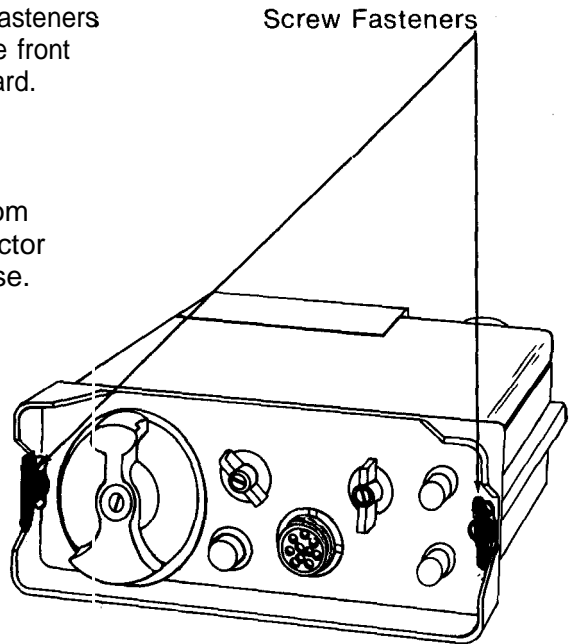

- Release the battery compartment catch so cover can be removed. Lift cover off.

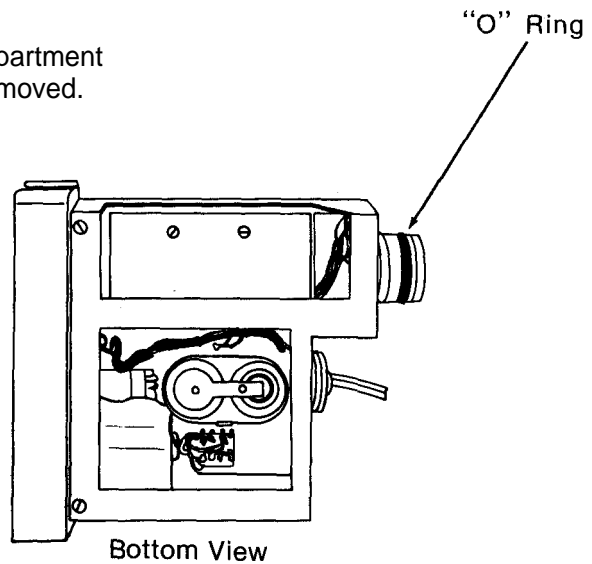

Cover

- Install two batteries. Place first battery in to the right, so that the flat bottom (negative electrode) rests on the spring on the floor of the compartment. Place other battery in to the left, next to first battery, so that the top portion (positive electrode) goes in first.

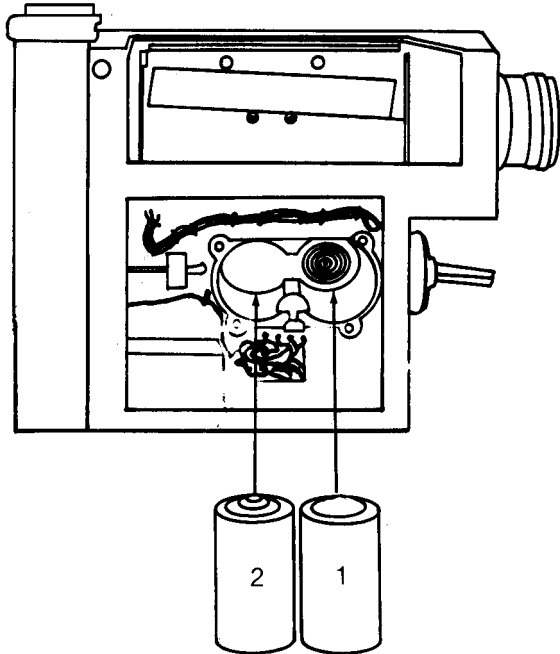

- Replace cover so that catch makes connection.



Cover

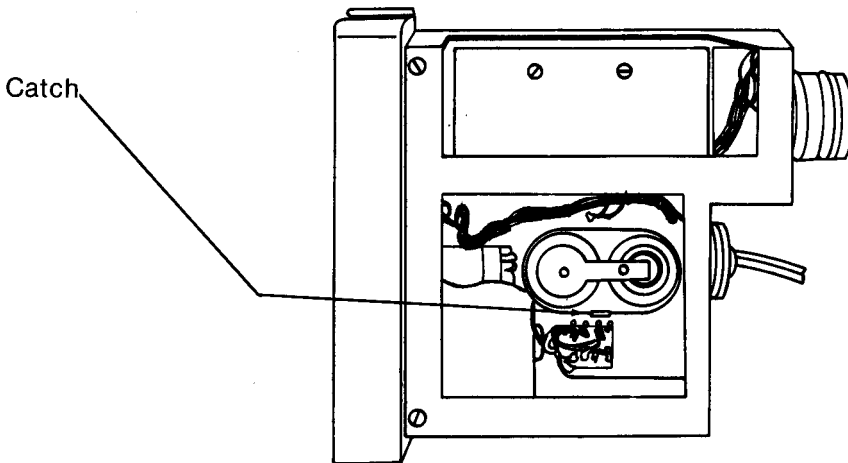

- Turn unit over so battery compartment is now on the bottom. Locate Bell/Lamp switch. Set the Bell/Lamp switch in either Bell or Lamp position according to your need.

- Replace the case. Tighten both thumb screw fasteners.

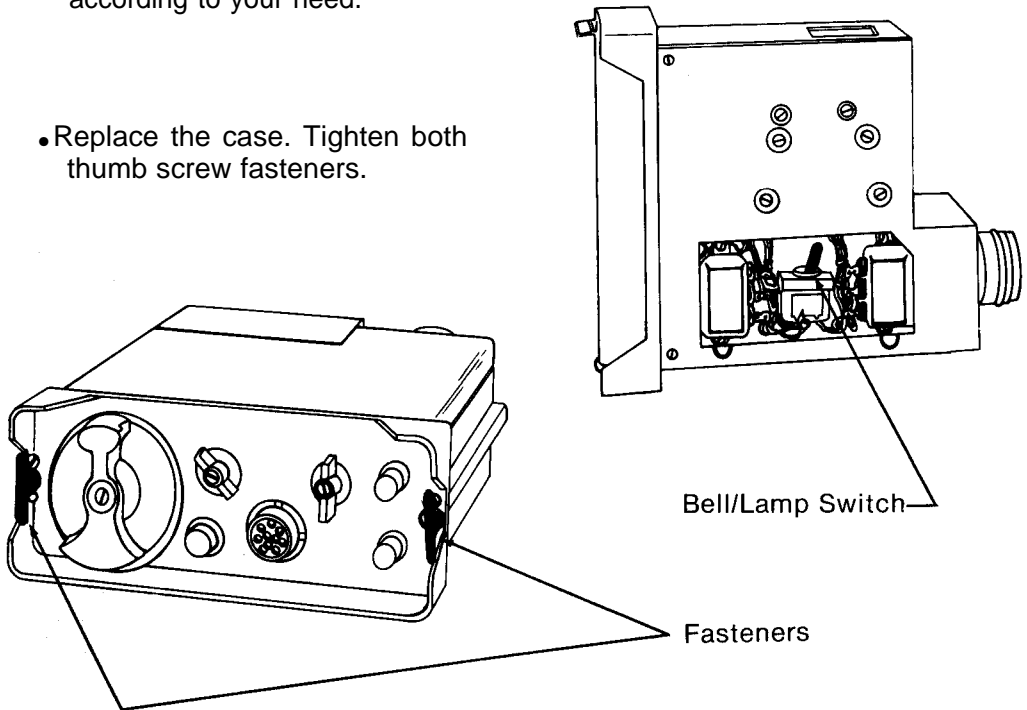

c. Local Control Connection

- If the unit is to be installed alongside or near the radio set and connected to front panel (not mounted), proceed as follows:

NOTE

Turn power OFF on the radio set before connecting the Local Control Unit.

- At the rear, open the cable compartment cover by pressing the latch at the top and laying cover down. Bring the two cables out.

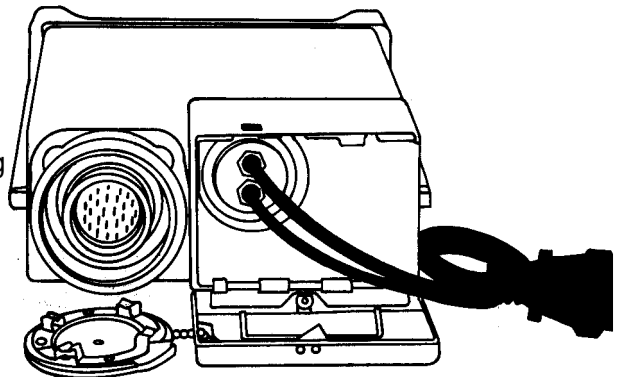

NOTE

Pull cables through case before closing case.

NOTE

If the Radio Set involved in the installation has two receiver-transmitters, one will be referred to as Set 1 and the other as Set 2. Refer to the instruction book of the particular Radio Set to determine which unit of the radio set is Set 1 and which is Set 2. Note also that Set 1 and/or Set 2 may be a receiver-transmitter, a radio receiver, a radio transmitter, an interphone amplifier, or some other push-to-talk (or push-to-transmit) type unit.

- Mount set first.

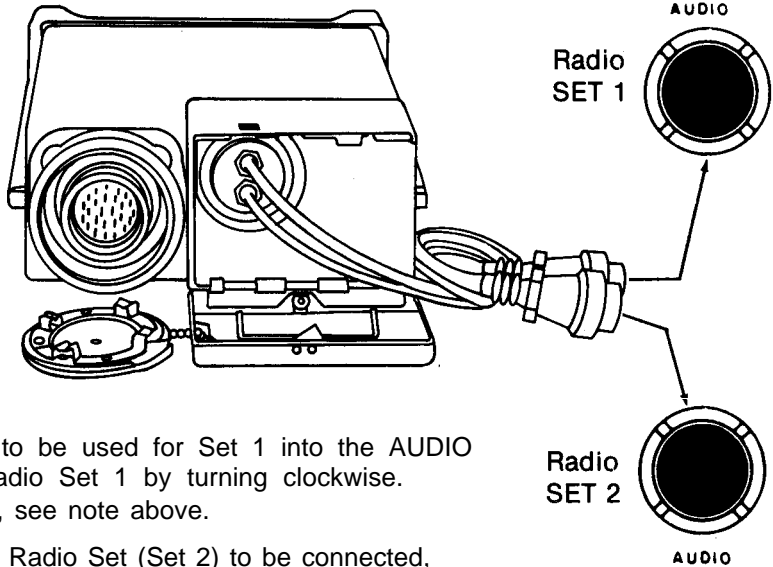

- Attach the cable to be used for Set 1 into the AUDIO connection of Radio Set 1 by turning clockwise. For cable choice, see note above.
- If there is another Radio Set (Set 2) to be connected, attach the other cable into the AUDIO connection of Radio Set 2 by turning clockwise.

- If only one radio is connected, store other cable in compartment.

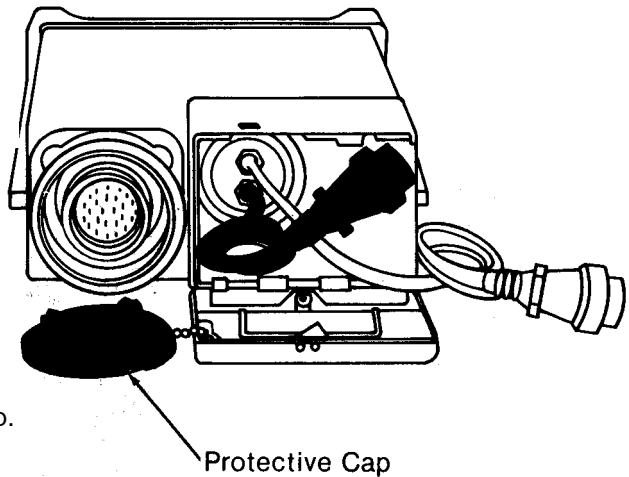

- Connector is not used now, so cover with protective cap.

- d. Local Control with mounting of radio set where mounting frame has been provided.

NOTE

Turn power OFF on the radio set before connecting the Local Control Unit.

- Remove protective cover plate from the large plug.

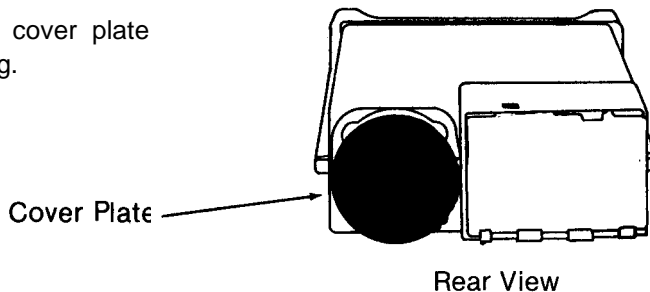

- Open the cable compartment cover by pressing the latch at the top and turning cover down.

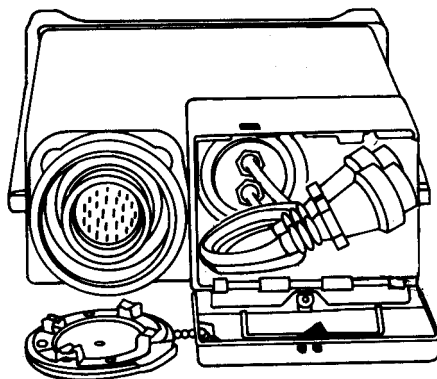

- Place cap on cap retaining bracket located on opened cable compartment cover. Close cover.

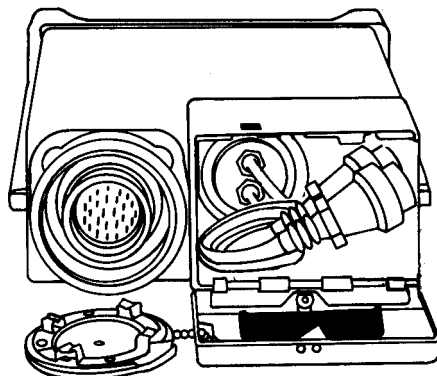

TM 11-5820-489-10
TO 31R4-2GRA6-31

- Insert the Control Unit's mounting runners (located on both sides of the case) into the mounting frame of the radio set.

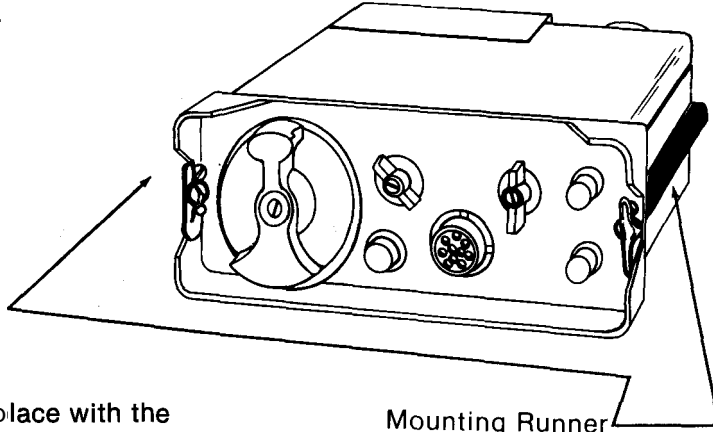

- Lock Unit in place with the locking lever (located on the right front portion of the mounting frame of the radio set).

- For electrical connection, plug mating connector (located on radio set mounting frame) into the connector on rear of local control unit.

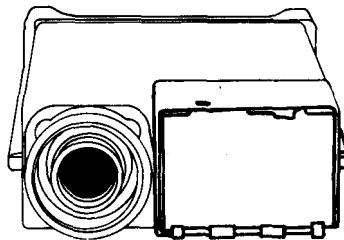

e. Installation of Accessories

- Handset - For Local or Remote Control, attach the Connector plug of the Handset into the AUDIO connector (located on the front panel). Turn clockwise to lock. When Handset is not in use, attach to storage area by using hang up clip.

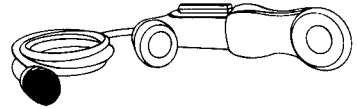

Be careful! When either unit is in use, the existing voltage at L1 and L2 may be as high as 90 volts. Use extreme caution.

- Telephone Lines - Remove about 3/4 inch of insulation from ends of two wires, leaving the wiring bare. Press and hold down binding post knobs. Insert end of one wire to binding post L1 and release. Connect the other bare wire end to L2. This is done at Local and Remote Control Units.

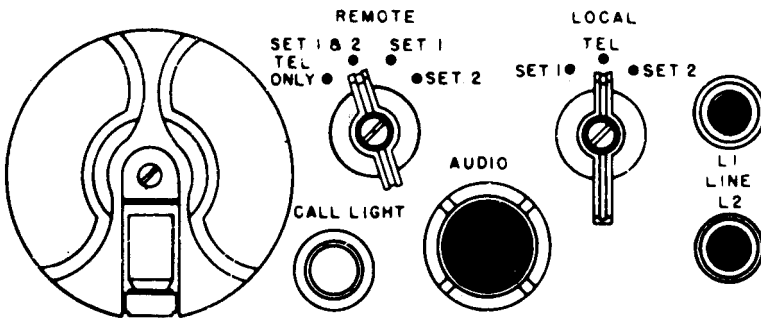
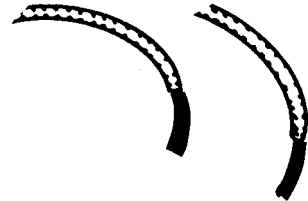

Local Control Unit

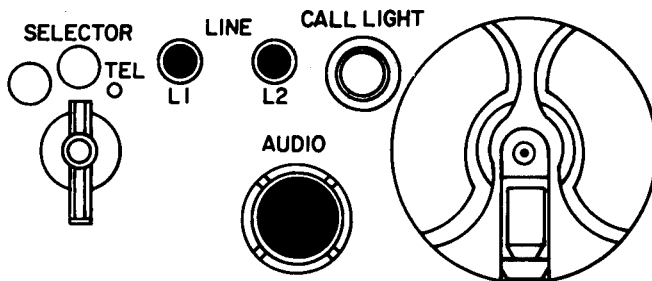

Remote Control Unit

2-5. INITIAL ADJUSTMENTS, DAILY CHECKS AND SELF-TEST

NOTE

Unless you are otherwise notified, the switches on the Remote and Local Control Units **MUST** be kept in the TEL and TEL ONLY positions. Besides keeping the Telephone lines continuously open, this prevents accidental operation of the radio set from the Remote Control area.

a. Check of Telephone Circuit

- Both operators (Local and Remote) must agree on time checks.
- To check ringing operation from either unit, crank (turn) generator handle (located on front panel) clockwise. At other Control Unit bell should ring or call light should light depending on switch setting.

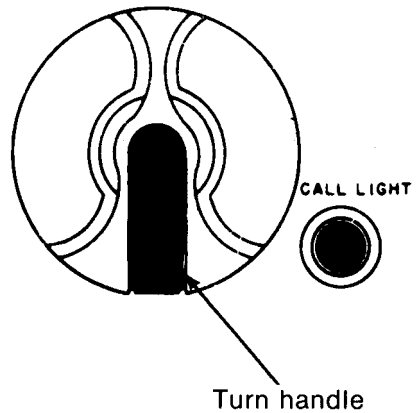

Be careful! When either unit is in use, the existing voltage at L1 and L2 may be as high as 90 volts. Use extreme caution.

- With TEL and TEL ONLY settings, check two-way telephone communication using push-to-talk swith on handset. THIS IS STANDBY POSITION.

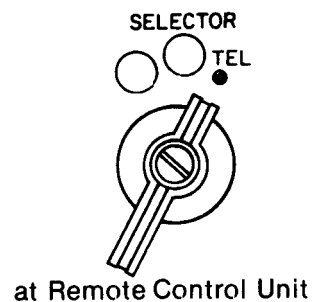
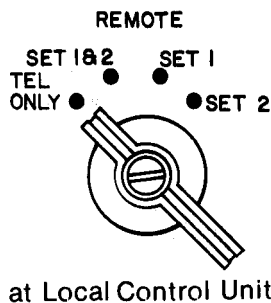

b. Filling in write-in blanks on Remote Control Unit

The Remote Control operator will fill in blank spaces with proper information according to instructions below.

NOTE

Remote Control write-in positions depend on the positions of the Local Control switches. It may be necessary to call and check the Local Unit for information.



When the Handset push-to-talk switch is operated at the Remote Control Unit, voltages as high as 90 volts dc are present at the line binding posts of both units.

Set 1 control using push-to-talk on Handset when power is controlled by Remote Unit.

- Set REMOTE switch to SET 1 position.

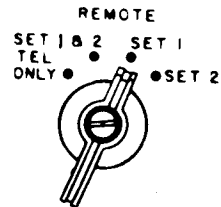

- Left-hand (LH) SELECTOR write-in position turns SET 1 power ON when remote operator presses push-to-talk.

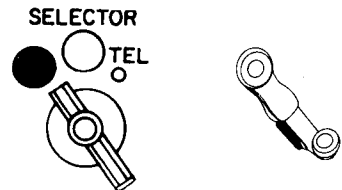

- Fill in "on" in blank.

- Middle (MID) SELECTOR write-in position turns SET 1 off when push-to-talk is pressed again.

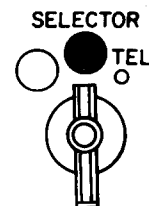

- Fill in "off" in blank.

Set 2 control using push-to-talk on Handset when power is controlled by Remote Unit.

- Set REMOTE switch to SET 2 position.

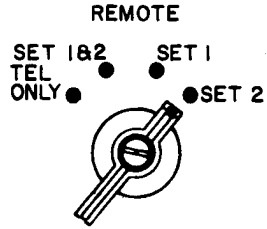

- LH SELECTOR write-in position turns SET 2 power ON when remote operator presses push-to-talk.

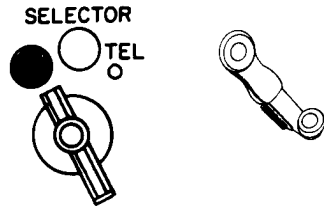

- Fill in "on" in blank.

- MID SELECTOR write-in position turns SET 2 power OFF when Remote operator presses push-to-talk again.

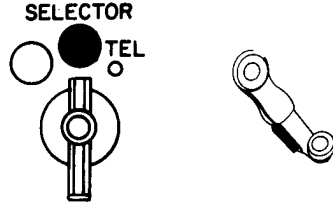

- Fill in "off" in blank.

Control of SET 1 and SET 2 when power is controlled by Local Unit.

- Set REMOTE switch to SET 1 and SET 2 position.

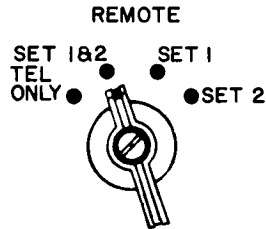

- Set to LH write-in position to give SET 1 power.

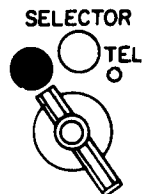

- Fill in "SET 1" in blank.
- Turn to MID write-in position to give SET 2 power.
- Fill in "SET 2" in blank.

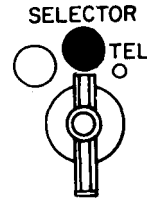

NOTE

This write-in set up is the intended plan. If the line connections are reversed, the system between the SELECTOR and REMOTE switches also will be reversed. To get this set-up, the next steps must be done.

2-6. OPERATING PROCEDURE

a. Telephone Communication (with ringing)

Remote operator begins conversation with other operator by sending ringing signal.

NOTE

To prevent accidental operation of the radio set by a ringing signal, keep the REMOTE switch of local control unit in the TEL ONLY position during standby and ringing periods.

- Set SELECTOR switch to TEL position.



- Crank ringing generator handle.



- Outgoing signal can be heard in Handset of sender.



Local operator talks with other operator by ringing.

- Local switch is in TEL position. REMOTE switch is in TEL ONLY position.

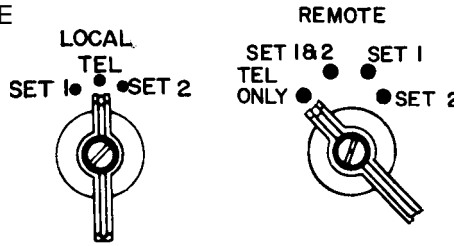

- Crank ringing generator handle at least 20 times.



- Out-going signal can be heard in handset of sender.

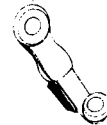

For talking and listening

Remote control operator talking and listening.

- Set SELECTOR switch to TEL position.

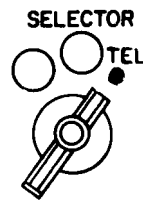

Push-to-talk Switch

- Press (push-to-talk) switch to talk.
- Release switch to listen.
- When done, release push-to-talk switch. Leave SELECTOR in TEL position.

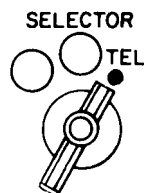

Local control operator talking and listening.

- Set LOCAL switch to TEL position and REMOTE switch to TEL ONLY position.

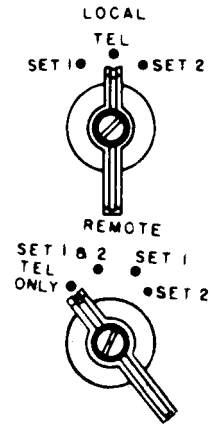
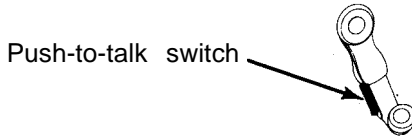

- Press (push-to-talk) switch to talk.
- Release switch to listen.
- When done, release push-to-talk switch.
- Leave switches in TEL and TEL ONLY positions.

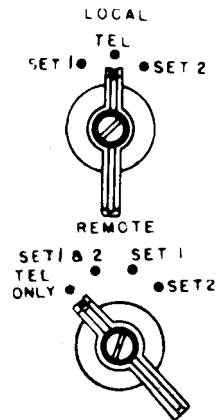

Remote Control Unit receives ringing signal.

- Set SELECTOR to TEL position.

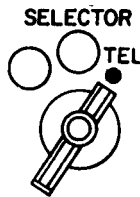

- To receive ringing signal, set BELL/LAMP switch (located in side of unit) to BELL position.

- To receive ringing signal on CALL LIGHT, set BELL/LAMP switch to LAMP.

BELL/LAMP switch

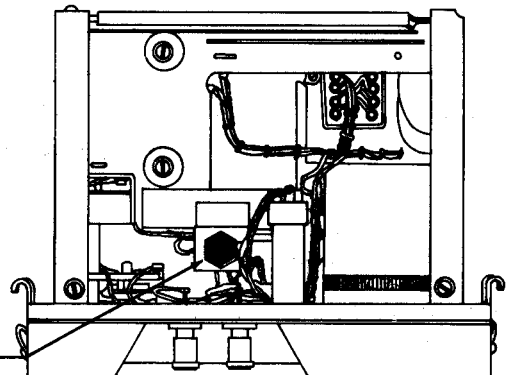

- Listen for bell or watch for light on panel.

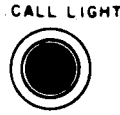

Call light may be adjusted to desired brightness by using dimmer. Turn rim on call light (dimmer) clockwise to dim and counterclockwise to brighten.

Local Control Unit receives ringing signal.

- Set LOCAL switch to TEL position and REMOTE switch to TEL ONLY position.

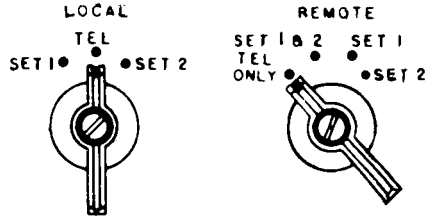

- To receive ringing signal, set BELL/LAMP switch to BELL.

BELL/LAMP switch

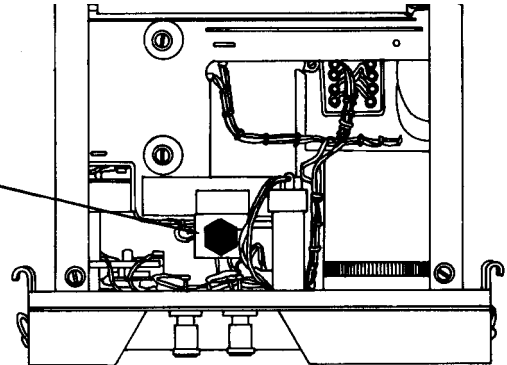

- To receive ringing signal on CALL LIGHT, set BELL/LAMP switch to LAMP.
- Listen for bell or watch for light on panel.



Push-to-talk operation from Remote Control Unit.

Remote push-to-talk operation of Set 1 with local control of power.

Remote operator will:

- Set SELECTOR at left-hand write-in position.



- Press push-to-talk switch to speak.



- Release switch to listen.

- When done, release push-to-talk switch and set SELECTOR switch to TEL.

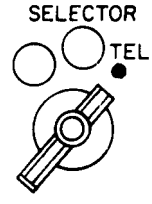

Local operator will:

- Set LOCAL switch to TEL.

- Set REMOTE switch to SET 1 position.

- When done, set REMOTE switch to TEL ONLY. Leave LOCAL switch in TEL.

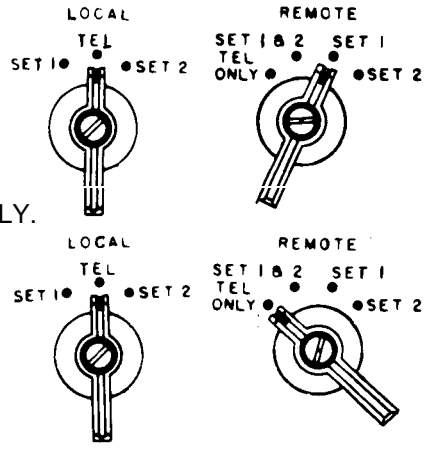

Remote push-to-talk operation of SET 2 with Local Control of radio set power.

Remote operator must:

- Set SELECTOR to MID write-in position.

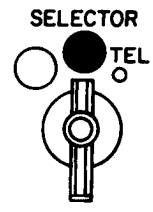

- Press push-to-talk switch.

- Release switch to listen.



- When done, release push-to-talk switch and set SELECTOR switch to TEL.

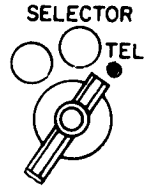

TM 11-5820-489-10
TO 31R4-2GRA6-31

Local operator must:

- Set LOCAL switch to TEL position and REMOTE switch to SET 2 position.

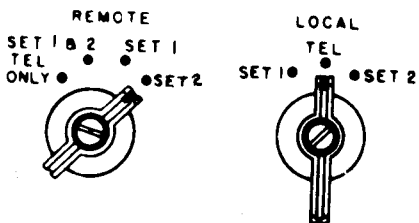

- When done, set REMOTE switch to TEL ONLY position and leave LOCAL in TEL position.



Remote push-to-talk operation of either SET 1 or SET 2 with Local Control of radio set.

Remote operator must:

- Set SELECTOR switch to LH position for SET 1 power or MID write-in position for SET 2 power.

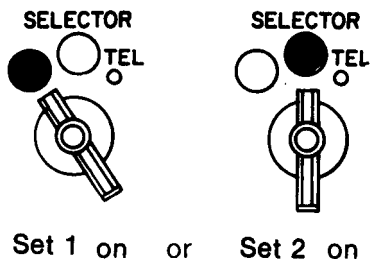

- Talk or listen to SET 1 or SET 2 using push-to-talk switch.



- When done, release push-to-talk switch. Set SELECTOR switch to TEL position.

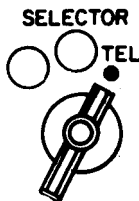

Local operator must:

- Set **LOCAL** switch to TEL position and **REMOTE** switch to SET 1 and 2.

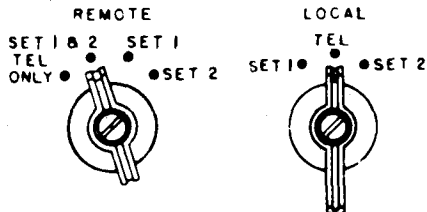

- When done, set **REMOTE** switch to TEL ONLY and leave **LOCAL** switch in TEL.

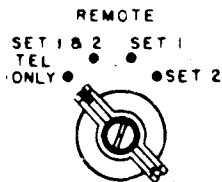

- c. Push-to-Talk from Local Control Unit
Local push-to-talk, release to listen operation.

- Transmit power is ON for either Set 1 or Set 2.



- Controls Set 1 or Set 2 at Remote Control Unit.

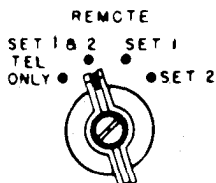

- d. Monitoring Operations at Local Control.

- Audio output signals of radio set can be heard by operator of all receivers or receiving circuits of the radio set. **REMOTE** switch is in any position **BUT TEL ONLY**.
- Direct transmission monitoring of the Remote operator can only be heard when the radio set is equipped with a sidetone circuit. Sidetone speech signals will be heard in the Local operator's handset.

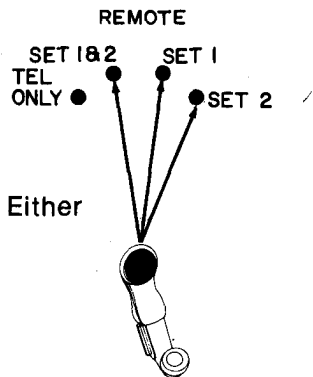

- Telephone and radio output reception can be monitored at the same time, if the Remote **SELEC-TOR** switch and the **LOCAL** switch are **BOTH** in the TEL position.

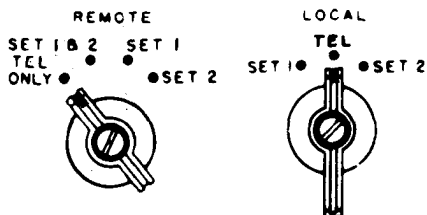

e. Monitoring Operations at Remote Control with the REMOTE switch in any position, but TEL ONLY.

- The remote operator can hear output of all receivers of the radio set and also speech transmission from the local operator.
- For all kinds of reception at the Remote Control Unit, LOCAL switch of Local Control must be in the TEL position.

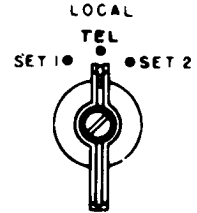
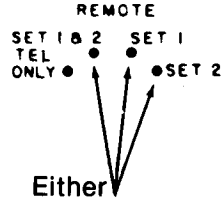

f. Break-in Operation

Break-in operation allows the operator to enter into a conversation between two other operators.

- Two-way Telephone Conversations makes it impossible to hear any of the receiver output signals of the radio set. Local Control operator can break the two-way telephone circuit at his end, by turning LOCAL switch to SET 1 or SET 2 position.
- Break-in by Local Control operator on Remote Control operation is possible when Remote operator is talking over radio set to distant radio operator.
- Turn LOCAL switch to TEL position and press push-to-talk.

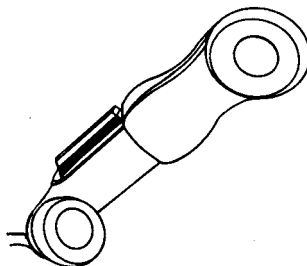
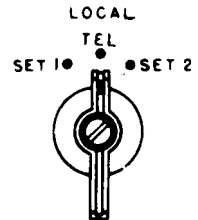
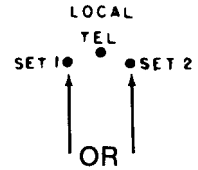

NOTE

Local operator's message will be transmitted if push-to-talk is used while remote operator is talking (watch timing).

- Local operator can take control of the radio set from the remote operator by the following method:
 1. If special installation provides for power control, turn radio power switch from REMOTE power ON position to LOCAL power ON position.

2. Turn REMOTE switch to SET 1 and 2.



3. Turn LOCAL switch to SET 1 or SET 2 (whichever is needed).

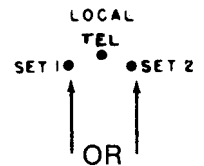

4. Press push-to-talk switch.
Release switch to listen.

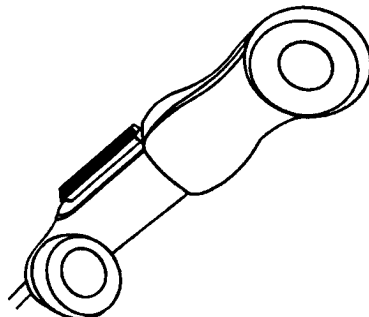

NOTE

Since the circuits between each of the two Control Group operators and the radio set are of the push-to-talk type, TIMING of the entry of the break-in operation into the conversation is IMPORTANT. Improper timing could result in unneeded interruptions or break-ins.

REMOTE

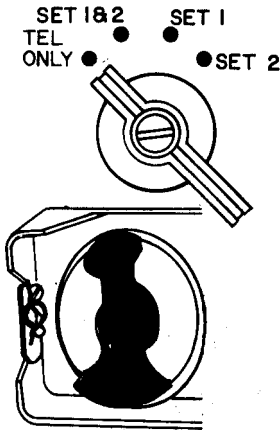

- Break-in by Remote Control operator on Local Control operations when local operator is talking over radio set with distant radio operator is possible when:

1. REMOTE switch of Local Control is in the TEL ONLY position. Then Remote operator sends 20 cycle ringing signal.

NOTE

If Remote switch is in any position other than TEL ONLY, call for emergency only.

REMOTE

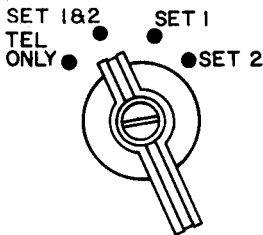

2. REMOTE switch of Local Control is in SET 1 and SET 2 position. Then Remote operator turns SELECTOR to either write-in position to contact SET 1 or SET 2. Click the push-to-talk switch to signal Local Control Unit.

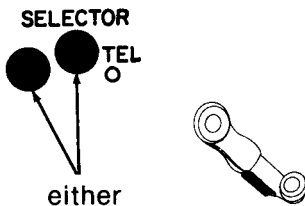

- Busy Circuit is shown when Remote operator hears local operator's conversation.

g. Stopping Procedures

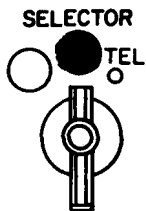

- Turn radio set power OFF according to radio set instructions.
- AT Remote Control Unit, turn SELECTOR switch to MID write-in position.
- Restore to stand-by condition as follows.

POSITION OF INDICATORS			
AT LOCAL CONTROL	AT REMOTE CONTROL	AT LOCAL CONTROL	AT REMOTE CONTROL
<p>REMOTE SET 1 & 2 SET 1 TEL ONLY</p> <p>LOCAL TEL SET 2 SET 1</p>	<p>SELECTOR</p>	<p>Release push-to-talk switch</p>	<p>Release push-to-talk switch</p>

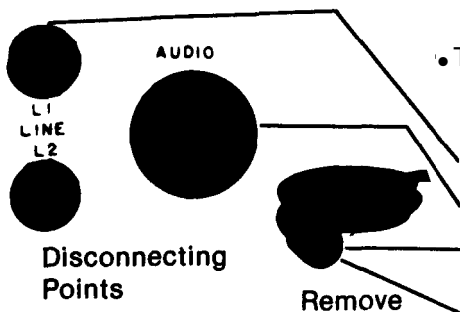

- To disconnect Control Group from radio set:
 1. Turn radio set power switch to OFF.
 2. Disconnect the lines.
 3. Disconnect Audio, accessories,
 4. Remove Local Control Unit from radio set or
 5. Remove the cables.

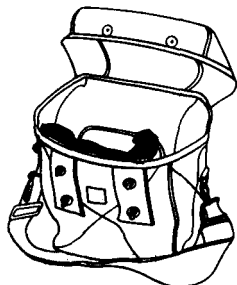

- When temporarily not in use, store components of Control Group in Bag.

CAUTION

If the Control Group will not be used for a long period of time, REMOVE the BATTERIES before storing the Units.

Section IV. OPERATION UNDER UNUSUAL CONDITIONS

2-7. GENERAL

The Control Group is designed to be operated in all types of temperature, humidity or weather conditions. But, special precautions may have to be taken when these conditions go to extremes. This section gives procedures to follow in extreme weather conditions.

2-8. OPERATION IN ARCTIC (BELOW ZERO) CLIMATES

- Handle all equipment with care.
- Keep equipment warm with the following insulations:
 - Kimpack
 - Spun glass fiber material
 - Animal skins
 - Woolen material
- Keep frost from microphone of handset. Cover with rubber or plastic diaphragm provided.
- If ice gets into Handset, remove cap and take ice out.
- Cold equipment may sweat. Bring to room temperature, then dry thoroughly.
- To prevent failure of batteries, protect them from the cold.
- Refer to TB 43-0118.

2-9. OPERATION IN TROPICAL CLIMATES

- Problems that may occur:
 - Extreme wetness
 - Fungus growth
 - Poor air flow
 - High humidity forming water on equipment
- To avoid these conditions:
 - Keep equipment dry.
 - Use heat from light bulbs or heaters to dry equipment.
 - **Refer to TB 43-0118.**

2-10. OPERATION IN DESERT CLIMATES

- Use dustproof containers to keep sand, dust, and dirt out of equipment.
- Protect moving parts such as the generator and switches.
- Cover equipment in containers with wet sacking.
- Line walls of container with heavy paper.
- NEVER tie telephone lines, or other wiring connections to tents (sudden winds can break the lines).
- Grit will damage switches and generator. Regular PMCS help avoid this dirt/grease build up.
- Refer to TB 43-0118.

CHAPTER 3

MAINTENANCE INSTRUCTIONS

	PAGE
Cleaning	3-4
Maintenance Procedures	3-1
Inspection	3-1
Introduction	3-1
Removal and Replacement	3-3
Batteries, Local Control	3-4
Batteries, Remote Control	3-3
Neon Lamps	3-3
Troubleshooting	3-1
Troubleshooting Information.. . . .	3-1

MAINTENANCE INSTRUCTIONS

Section I. TROUBLESHOOTING

3-1. TROUBLESHOOTING INFORMATION

This information will be restricted to the use of operational test explained in paragraph 2-8.

If the problem cannot be solved by the operator, through Operator's Preventive Maintenance, a higher maintenance or repair level is needed

- Report any malfunctions or equipment failures on proper Form DA-2404 or, refer to TM 38-750.

Section II. MAINTENANCE PROCEDURES

3-2. INTRODUCTION

The operator of this Control Group will be required to do certain maintenance tasks, such as inspection and service.

3-3. INSPECTION

- Inspect the following switches for smooth mechanical action, freedom from external or internal binding, and excessive looseness:

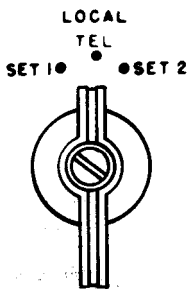

LOCAL switch (at both units)

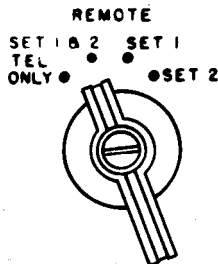

REMOTE switch (at Local unit)



SELECTOR switch (at Remote unit)

- Inspect the following for frayed insulation, cracking, excessively worn areas or chafing:

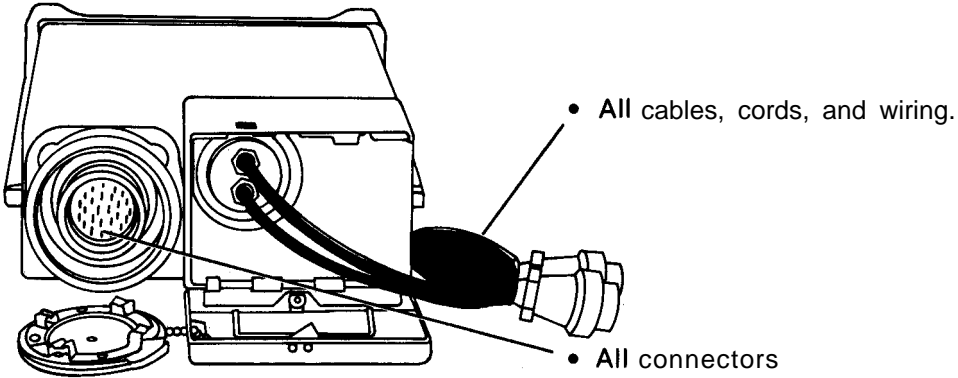

- Inspect the following for looseness, dents, rust, and corrosion:

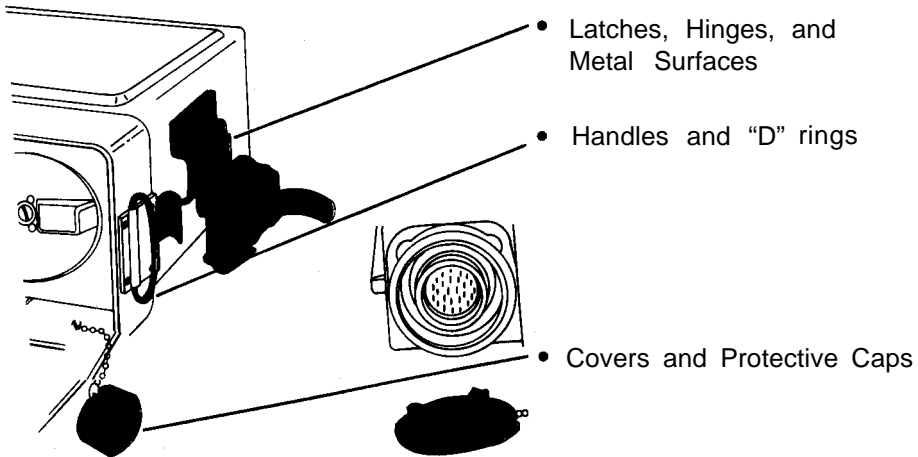

- Inspect the following for loose terminals, leakage, rust, corrosion, and moisture:

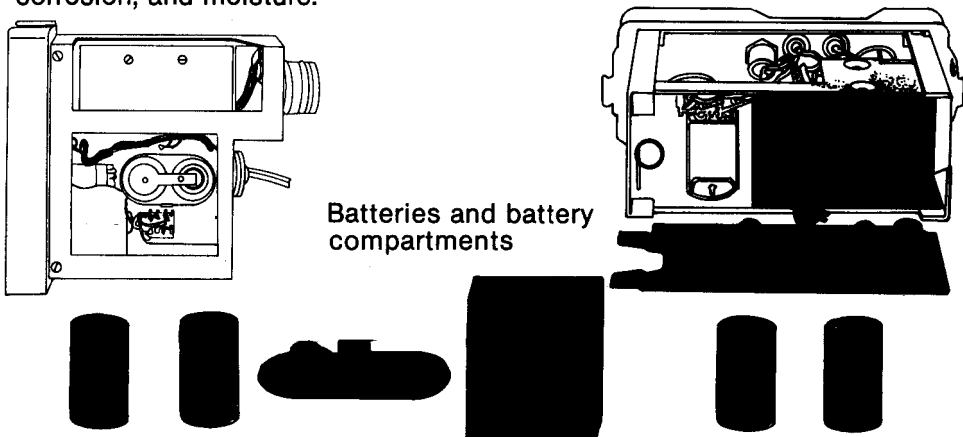

Light bulbs - remove unit from case. On Local Unit the BA-30's must be removed first.

3-4. REMOVAL AND REPLACEMENT

a. Neon Lamps (Remote Control C-433/GRC).

- Release the two snap catches holding the outer case to the panel and chassis assembly.
- Remove unit from case.
- Pull the lampholder to the rear, out of the receptacle.
- Push and $\frac{1}{4}$ turn lamp counterclockwise. Pull the defective lamp out of the holder.
- Push a replacement lamp into the lampholder, $\frac{1}{4}$ turn clockwise and make sure it is properly seated.
- Replace the lampholder in the receptacle.
- Replace unit in case.

b. Neon Lamps (Local Control C-434/GRC).

- Loosen the thumbscrew fasteners on the front panel of unit, and remove the panel and chassis assembly from the case.
- Pull the lampholder to the rear out of the receptacle.
- Push and $\frac{1}{4}$ turn lamp counterclockwise. Pull the defective lamp out of the holder.
- It may be necessary to remove the BA-30 batteries to remove/replace lamp.
- Push a replacement lamp into the lampholder and $\frac{1}{4}$ turn clockwise and make sure it is properly seated.
- Replace the lampholder in the receptacle.
- Replace unit in case.

c. Batteries (Remote Control C-433/GRC).

- Release the two snap catches holding the outer case to the panel and chassis assembly. Remove the assembly from the case.
- Slide the battery compartment cover back to clear the tabs on one side. Remove the cover.
- Remove the two batteries (BA-30) from the battery compartment.
- Unplug the battery cable from the socket on the end of the large battery (BA-414/U). Remove the large battery from the battery compartment.
- Replace two fresh batteries (BA-30) in the battery compartment (alternate polarities).
- Replace large battery (BA-414/U) in battery compartment and insert battery cable into socket at end of the battery. The socket at the end of the battery should be facing outward, toward the rear of the Unit.
- Replace the battery compartment cover by first inserting the tabs on one side of the cover under the bracket angles on the side of the chassis frame. Then, slide the cover forward and press to lock it into place.
- Replace Unit in case and secure the two snap catches.

d. Batteries (Local Control C-434/GRC).

NOTE

It may be necessary to remove the "O" ring from the power cable connector to remove Unit from case.

- Loosen the thumbscrew fasteners on the front panel of Unit, and remove the panel and chassis assembly from the case.
- Turn the panel and chassis assembly bottom side up and release the catch that holds the battery compartment cover in place.
- Remove the cover.
- Remove two batteries (BA-30).
- Place two fresh batteries in the battery compartment (alternate polarities).
- Replace the battery compartment cover.
- Replace Unit in case and secure thumbscrew fasteners.
- Replace "O" ring on power cable connector.

3-5. CLEANING

Service will be restricted to cleaning, dusting, or washing.



Adequate ventilation should be provided while using TRICHLOROTRIFLUOROETHANE. Prolonged breathing of vapor should be avoided. The solvent should not be used near heat or open flame; the products of decomposition are toxic and irritating. Since TRICHLOROTRIFLUOROETHANE dissolves natural oils, prolonged contact with skin should be avoided. When necessary, use gloves which the solvent cannot penetrate. If the solvent is taken internally, consult a physician immediately.

a. Remove grease, fungus and ground-in dirt from your equipment with a cloth dampened with cleaning solvent.

b. Dust or wash with clean, soft cloth.

**APPENDIX A
REFERENCES**

A-1. INTRODUCTION

This appendix lists all forms and publications that contain information on the operation and maintenance of Group Control AN/GRA-6.

A-2. FORMS

Recommended Changes to Equipment Technical
Publications DA Form 2028-2
Equipment Inspection and Maintenance Worksheet DA Form 2404
Quality Deficiency Report (for EIR) SF 368

A-3. TECHNICAL MANUALS

Operator's and Organization Maintenance: Multimeter
AN/URM-105 and AN/URM-105C (Including Multimeter
ME-77/U and ME-77C/U TM 11-6625-203-12
Operator's and Organizational Maintenance Manual:
Voltmeter, Meter ME-30A/U and Voltmeters, Electronic
ME-30B/U, ME-30C/U and ME-30E/U TM 11-6625-320-12
Operator, Organizational, DS, GS, and Depot Maintenance
Manual: Audio Oscillator TS-421C/U
(NSN 6625-00-435-2588) TM 11-6625-355-15-1
Operator's, Organizational, DS, GS and Depot Maintenance
Manual: Multimeter TS-352B/U (NSN 6625-00-553-0142) TM 11-6625-366-15
Operator, Organizational, Field and Depot Maintenance
Manual: Test Facilities Kit, Radio MK-153/GRC. TM 11-6625-408-15
Administrative Storage of Equipment. TM 740-90-1
Hand Receipt Manual TM 11-5820-489-10-HR
The Army Maintenance Management System (TAMMS) TM 38-750

A-4. MISCELLANEOUS PUBLICATIONS

Consolidated Index of Army Publications and Blank Forms DA Pam 310-1
FSC Class 6135, Dry Battery Supply Data SB 11-6
Field Instructions for Painting and Preserving Electronics
Command Equipment Including Camouflage Pattern
Painting of Electrical Equipment Shelters. TB 43-0118

APPENDIX B

COMPONENTS OF END ITEM

Section I. INTRODUCTION

B-1. Scope

This appendix lists integral components of and basic issue items for the AN/GRA-6 to help you inventory items required for safe and efficient operation.

B-2. General

This Components of End Item List is divided into the following sections:

a. Section II. Integral Components of the End Item. Not applicable. These items, when assembled, comprise the AN/GRA-6 and must accompany it whenever it is transferred or truned in. The illustrations will help you identify these items.

b. Section III. Basic Issue Items. Not applicable. These are the minimum essential items required to place the AN/GRA-6 in operation, to operate it, and to perform emergency repairs. Although shipped separately packed they must accompany the AN/GRA-6 during operation and whenever it is transferred between accountable officers. The illustrations will assist you with hard-to-identify items. This manual is your authority to requisition replacement BII, based on TOE/MTOE authorization of the end item.

B-3. Explanation of Columns

a. Column (1) - Illustration Number (Illus Number). This column indicates the number of the illustration in which the item is shown.

b. Column (2) - National Stock Number. Indicates the National stock number assigned to the item and will be used for requisitioning purposes.

c. Column (3) - Description. Indicates the National item name and, if required, a minimum description to identify and locate the item. The last line for each item indicated the FSCM (in parentheses) followed by the part number.

d. Column (4) - Unit of Measure (U/M). Indicates the measure used in performing the actual operational/maintenance function. This measure is expressed by a two-character alphabetical abbreviation (e.g., ea, in, pr).

e. Column (5) - Quantity required (Qty Rqd). Indicates the quantity of the item authorized to be used with/on the equipment.

1

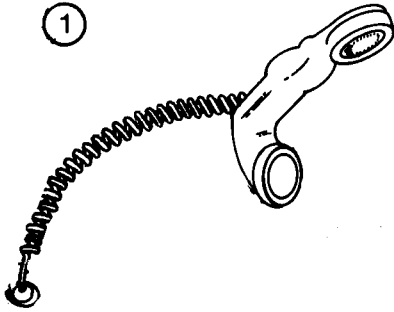

Handset H-33/PT

2

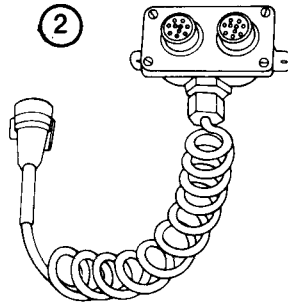

Interconnecting Box J-654/G

3

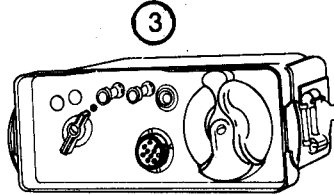

Local Control C-434/GRC

4

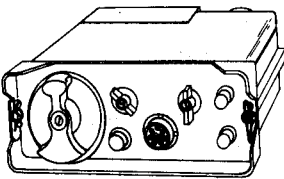

Remote Control C-433/GRC

5

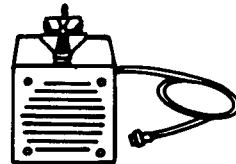

Loudspeaker, Dynamic LS-166/U

SECTION II. COMPONENTS OF END ITEM

(1) ILLUS. NO.	(2) NATIONAL STOCK NUMBER	(3) DESCRIPTION (FSCM) AND PART NUMBER	USABLE ON CODE	(4) U/M	(5) QTY REQD
1	5965-00-163-9947	HANDSET (BLACK PLASTIC BATTERY POWERED MAGNETIC)		EA	2
2	5820-00-511-4319	INTERCONNECTING BOX (3/8 IN. DIA. CABLE ACCOM. ALU. W/COVER) 85578	(80063)	EA	1
3	5820-00-170-4781	LOCAL CONTROL (MANUAL CONTROL AC-DC) 42368	(80063)	EA	1
4	5820-00-170-5171	REMOTE CONTROL (MANUAL CONTROL AC-DC) 42454	(80063)	EA	1
5	5965-00-243-6420	LOUDSPEAKER (DYNAMIC) 2677	(80063)	EA	1

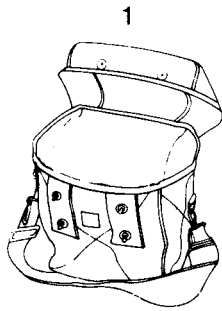

Bag CW-189/GRC

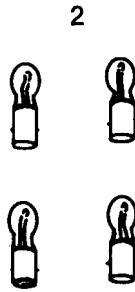

Running Spares

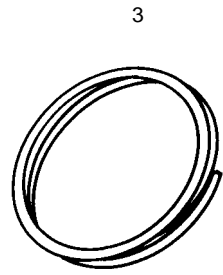

Line WD-1/TT

SECTION III. BASIC ISSUE ITEMS

(1) ILLUS. NO.	(2) NATIONAL STOCK NUMBER	(3) DESCRIPTION (FSCM) AND PART NUMBER	USABLE ON CODE	(4) U/M	(5) QTY REQD
1	5820-00-404-6885	BAG (COTTON DUCK, OLIVE DRAB) FOR CARRYING AND STORING CONTROL GROUP 40635	(80063)	EA	1
2	6240-00-223-9100	RUNNING SPARES - GE NE-51 LAMP, GLOW, NEON, 2 FOR LOCAL AND 2 FOR REMOTE CONTROL 49956		SET	1
		TECHNICAL MANUAL (TM 11-5620-489-10)		EA	2
3		TELEPHONE LINE (WD-1/TT)		FT	2

APPENDIX C

ADDITIONAL AUTHORIZATION LIST

Section I. INTRODUCTION

C-1. SCOPE

This appendix lists additional items you are authorized for the support of the Control Group.

C-2. GENERAL

This list identifies items that do not have to accompany the Control Group and that do not have to be turned in with it. These items are all authorized to you by CTA, MTOE, TDA, or JTA.

C-3. EXPLANATION OF LISTING

National stock numbers, descriptions, and quantities are provided to help you identify and request the additional items you require to support this equipment. The items are listed in alphabetical sequence by item name under the type document (i.e., CTA, MTOE, TDA, or JTA) which authorizes the item(s) to you. If the item you require differs between serial numbers of the same model, effective serial numbers are shown in the last line of the description. If the item required differs for different models of this equipment, the model is shown under the "Usable On" heading in the description column.

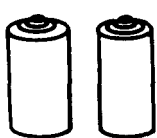

1

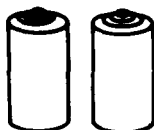

2

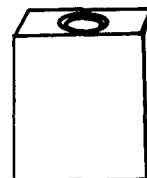

Battery, Dry BA-30

Battery, Dry BA-414/U

SECTION II. ADDITIONAL AUTHORIZATION LIST

(1) ILLUS NO.	(2) NATIONAL STOCK NUMBER	DESCRIPTION (FSCM) AND PART NUMBER	USABLE ON CODE	U/M	QTY REQD
1	6135-00-120-1020	BATTERY, DRY (1.5V FOR LOCAL CONTROL AND REMOTE CONTROL)		EA	2
2	6135-00-125-5256	BATTERY, DRY (45V TOPPED AT 22V) FOR REMOTE CONTROL		EA	1

APPENDIX D

EXPENDABLE SUPPLIES AND MATERIALS LIST

Section I. INTRODUCTION

D-1. SCOPE

This appendix lists expendable supplies and materials you will need to operate and maintain the Control Group. These items are authorized to you by CTA 50-970, Expendable Items (Except Medical, Class V, Repair Parts, and Heraldic Items).

D-2. EXPLANATION OF COLUMNS

a. Column (1) - Item Number. This number is assigned to the entry in the listing and is referenced in the narrative instructions to identify the material (e.g., "Use cleaning compound, item 2, App. D").

b. Column (2) - Level. This column identifies the lowest level of maintenance that requires the listed item.

C - Operator/Crew

c. Column (3) - National Stock Number. This is the National stock number assigned to the item; use it to request or requisition the item.

d. Column (4) - Description. Indicates the Federal item name and, if required, a description to identify the item. The last line for each item indicates the Federal Supply Code for Manufacturer (FSCM) in parentheses.

e. Column (5) - Unit of Measure. Indicates the measure used in performing the actual maintenance function. This measure is expressed by a two-character alphabetical abbreviation (e.g., ea, in, pr). If the unit of measure differs from the unit of issue, requisition the lowest unit of issue that will satisfy your requirements.

Section II. EXPENDABLE SUPPLIES AND MATERIALS LIST

(1) ITEM NO.	(2) LEVEL	(3) NATIONAL STOCK NUMBER	(4) DESCRIPTION	(5) U/M
1	c	8305-00-267-3015	Cleaning cloth	yd.
2	c	6850-00-105-3084	Trichlorotrifluoroethane Cleaning compound	oz.

GLOSSARY

ALTERNATING CURRENT (ac) - Electric current flowing two ways, continuously, reversing direction and changing in power.

AUDIO - Portion of soundwaves that can be heard.

BREAK-IN - Ability to enter into or interrupt a conversation.

BREAK-IN OPERATION - The ability of an operator to enter into or interrupt a conversation between two talking positions.

BINDING POST - Connectors (L1 and L2) used for the connection of wire ends.

CRANK - Handle used to turn generator, thus creating energy.

DIRECT CURRENT (dc) - Electric current flowing one way and constant in value.

INPUT - Information taken in.

HERTZ - Unit of frequency expressed in cycles per second.

KIMPACK WRAPPING - Inside covering used for packing or repacking.

NEGATIVE ELECTRODE - Pertains to batteries - end that does not conduct energy (usually flat end).

MONITORING - To observe.

OCTAL PLUG - Eight pronged plug that fits into the end of the octal socket of a battery.

OCTAL SOCKET - Socket which accepts eight pronged plug.

OHM - Unit of electrical resistance equal to resistance of a circuit where a possible difference of one volt produces a current of one ampere.

OUTPUT - Information given out.

POLARITY - Either positive or negative. Indicates which lead is to be connected to a given point.

POSITIVE ELECTRODE - Pertains to batteries - end that conducts energy (usually the raised end).

GLOSSARY - Continued

RECEIVER - Person or radio set that gets radiowave signals from a transmitter.

RUNNING SPARES - Extra park provided with the original equipment.

SIDE TONE - Sound of your own transmission heard in handset earphone.

STAND-BY - Refers to the switch position used to maintain a continuous telephone circuit between the Local and Remote Operators. This switch position (TEL at Local Control and TEL ONLY at Remote Control) also prevents accidental operation of the Radio Set at Remote Control.

TRANSMISSION - A way to send radio waves by signals or messages to a receiving station.

TRANSMITTER - The person or radio set that sends a signal.

INDEX

SUBJECT	PAGE
A	
Abbreviations	1-2
Adjustments, Initial	2-24
Arctic, Operation in	2-38
Assembly and Installation	
Accessories	2-23
Batteries	2-13
Cables	2-19
Local Control	2-17
Loudspeaker	2-16
Radio Set	2-14
Remote Control	2-13
Auxiliary Components	
Handset	B-2
Running Spares	B-3
B	
Bag	1-3
Batteries	
Compartment Cover	1-4
In Local Control	3-4
In Remote Control	3-3
Installation of	2-13
Notion	1-7
Blanks, Write-in	2-25
Break-in	2-34
Busy Circuit	2-36
C	
Cable Assembly	2-19
Cable Compartment	1-5, 2-19
Cap	1-5, 2-20
Connector	2-22
Carrying Strap	1-3
Checks, Maintenance	2-8
Circuit, Telephone	2-24
Cleaning	3-4
Components, Auxiliary	
Handset	B-2
Running Spares	B-3
Connector, Audio.	2-4

INDEX - Continued

SUBJECT	PAGE
C	
Control Group	
Capabilities	1-2
Description	1-3
Features	1-2
Operation Instruction	2-0
Operation in Unusual Conditions	2-38
Operation in Usual Conditions	2-13
Performance Data	1-6
Purpose	1-2
Control, Local	
Batteries	2-17, 3-4
Break in with	2-34
Cable Compartments	1-5, 2-19
Cap	1-5, 2-20
Monitoring	2-33
"O" Rings	2-17
Operating Procedures	2-27
Panel Front	2-1
Control, Remote	
Batteries	2-13, 3-3
Battery Compartment	1-4
Break in	2-36
"D" Rings	1-4
Description of	1-3
Installation	2-13
Monitoring	2-34
Operating Instructions	2-27
Panel, Front	2-5
Controls	2-5
Cross-Reference List, Nomenclature	1-1

Data, Performance	1-6
Description of Major Components	1-3
Desert Operations	2-38
Difference in Models	1-6
"D"Rings	1-4

F

Features of Equipment	1-2
Forms, Records and Reports	1-1

INDEX - Continued

SUBJECT	PAGE
G	
Generator, Ringing	2-4
H	
Handset	
Description	1-3
Installation	2-23
Using Push-to-Talk	2-28
I	
Indicators	
Call Light	2-4
Dimmer	2-4
Local Switch	2-1
Remote Switch	2-2
Selector Switch	2-5
Initial Adjustments	2-24
Interconnection Box	
Description	1-3
Installation	2-16
Inspection	3-1
Installation and Assembly	
Accessories	2-23
Batteries	2-13
Cables	2-19
Local Control	2-17
Radio Set to Local Control	2-19
Remote Control	2-13
L	
Lamps, Neon	1-7, 3-3
Lines, Telephone	2-23
Local Control	
Batteries	2-17, 3-4
Battery Compartment in	2-17
Break-in with	2-34
Cable Compartment of	1-5
Cap	1-5
Description	1-3
Installation	2-17
Monitoring	2-33
Operating Procedures	2-27
Panel, Front	2-1

INDEX - Continued

SUBJECT	PAGE
L	
Loudspeaker Push-to-Talk	2-16
Data	1-6
Installation	2-16
M	
Maintenance	
Cleaning	3-5
Inspection	3-1
PMCS Procedures	2-8
Preventive	2-8
Routine	2-9
Troubleshooting	3-1
Models, Differences in	1-6
Monitoring	2-33
Mounting, Connection to Local Control	2-22
N	
Neon Lamps	1-7, 3-3
Nomenclature Cross-Reference List	1-1
O	
“O” Rings	2-17
Operation	
In Arctic	2-38
In Desert	2-38
In Tropical	2-38
Procedures	2-27
Remote Control	2-30
Unusual Conditions	2-38
Usual Conditions	2-13
P	
Panel	
Of Local Control	2-1
Of Remote Control	2-5
Performance Data	1-6
PMCS	2-8
Procedures	
Maintenance	2-8
Operating	2-27
Stopping	2-37
Publications	A-1

INDEX - Continued

SUBJECT	PAGE
P	
Push-to-Talk	
From local control	2-26
From remote control	2-25
R	
Radio Set	
Connecting to local control	2-19
Mounting to local control	2-22
Range of Transmission	1-2
Receptacle connectors	2-4
Records, Forms and Reports.	1-1
Remote Control	
Batteries	2-14, 3-3
Battery compartment in.	1-4
Break-in	2-36
"D" rings on	1-4
Description of	1-3
Installation	2-13
Monitoring	2-34
Operating procedures	2-27
Panel, Front	2-5
Push-to-Talk	2-25
Removal and Replacement	
Batteries for local	3-4
Batteries for remote	3-3
Neon lamps for local	3-3
Neon lamps for remote	3-3
Ringling signal	2-28
Rings	
"D"	1-4
" O "	2-17
Running spares	B-3
S	
Signals, Ringing	2-28
Spares, Running	B-3
Stand-by	2-24
Stopping Procedures	2-37
Strap, Carrying	1-3

INDEX - Continued

SUBJECT	PAGE
T	
Telephone	
Busy Circuit	2-36
Check of Circuit	2-24
Lines	2-23
Ring Signal	2-30
Two-Way Communication.	2-34
Transmission Range	1-2
Troubleshooting	3-1
U	
Unusual Conditions	
Operation in	2-38
Usual Conditions	
Operation in	2-13
W	
Write-in Blanks.	2-25

RECOMMENDED CHANGES TO EQUIPMENT TECHNICAL PUBLICATIONS



THEN... JOT DOWN THE DOPE ABOUT IT ON THIS FORM. CAREFULLY TEAR IT OUT. FOLD IT AND DROP IT IN THE MAIL!

SOMETHING WRONG WITH THIS PUBLICATION?

FROM: (PRINT YOUR UNIT'S COMPLETE ADDRESS)
 Commander
 Stateside Army Depot
 ATTN: AMSTA-US
 Stateside, N.J. 07703

DATE SENT 10 July 1975

PUBLICATION NUMBER
 TM 11-5840-340-12

PUBLICATION DATE
 23 Jan 74

PUBLICATION TITLE
 Radar Set AN/PRC-76

BE EXACT PIN-POINT WHERE IT IS

PAGE NO	PARA-GRAPH	FIGURE NO	TABLE NO
2-25	2-28		
3-10	3-3		3-1
5-6	5-8		

IN THIS SPACE TELL WHAT IS WRONG AND WHAT SHOULD BE DONE ABOUT IT:

Recommend that the installation antenna alignment procedure be changed throughout to specify a 2° IFF antenna lag rather than 1°.

REASON: Experience has shown that with only a 1° lag, the antenna servo system is too sensitive to wind gusting in excess of 25 knots, and has a tendency to rapidly accelerate and decelerate as it hunts, causing strain to the drive train. Hunting is minimized by adjusting the lag to 2° without degradation of operation.

Item 5, Function column. Change "2 db" to "3db."

REASON: The adjustment procedure for the TRANS POWER FAULT indicator calls for a 3 db (500 watts) adjustment to light the TRANS POWER FAULT indicator.

Add new step f.1 to read, "Replace cover plate removed in step e.1, above."

REASON: To replace the cover plate.

Zone C 3. On J1-2, change "+24 VDC to "+5 VDC."

REASON: This is the output line of the 5 VDC power supply. +24 VDC is the input voltage.

TEAR ALONG PERFORATED LINE

PRINTED NAME, GRADE OR TITLE, AND TELEPHONE NUMBER
 SSG I. M. DeSpirito 999-1776

SIGN HERE

DA FORM 2028-2 JUL 79

PREVIOUS EDITIONS ARE OBSOLETE.

P.S. --IF YOUR OUTFIT WANTS TO KNOW ABOUT YOUR RECOMMENDATION MAKE A CARBON COPY OF THIS AND GIVE IT TO YOUR HEADQUARTERS

FILL IN YOUR
UNIT'S ADDRESS

FOLD BACK

DEPARTMENT OF THE ARMY

OFFICIAL BUSINESS
PENALTY FOR PRIVATE USE \$300

SAMPLE

Commander
US Army Communications-Electronics Command
and Fort Monmouth
ATTN: DRSEL-ME-MP
Fort Monmouth, New Jersey 07703

TEAR ALONG PERFORATED LINE

RECOMMENDED CHANGES TO EQUIPMENT TECHNICAL PUBLICATIONS



SOMETHING WRONG WITH THIS PUBLICATION?

THEN...JOT DOWN THE DOPE ABOUT IT ON THIS FORM. CAREFULLY TEAR IT OUT, FOLD IT AND DROP IT IN THE MAIL.

FROM: (PRINT YOUR UNIT'S COMPLETE ADDRESS)

DATE SENT

PUBLICATION NUMBER
TM 11-5820-489-10

PUBLICATION DATE
23 Nov 83

PUBLICATION TITLE
Control Group AN/GRA-6

BE EXACT PIN-POINT WHERE IT IS

PAGE NO.	PARA-GRAPH	FIGURE NO.	TABLE NO.
----------	------------	------------	-----------

IN THIS SPACE TELL WHAT IS WRONG AND WHAT SHOULD BE DONE ABOUT IT:

TEAR ALONG PERFORATED LINE

PRINTED NAME GRADE OR TITLE AND TELEPHONE NUMBER

SIGN HERE

DA FORM 2028-2
1 JUL 79

PREVIOUS EDITIONS ARE OBSOLETE

P.S.--IF YOUR OUTFIT WANTS TO KNOW ABOUT YOUR RECOMMENDATION MAKE A CARBON COPY OF THIS AND GIVE IT TO YOUR HEADQUARTERS.

FILL IN YOUR
UNIT'S ADDRESS

FOLD BACK

DEPARTMENT OF THE ARMY

OFFICIAL BUSINESS
PENALTY FOR PRIVATE USE \$300

Commander
US Army Communications-Electronics Command
and Fort Monmouth
ATTN: DRSEL-ME-MP
Fort Monmouth, New Jersey 07703

TEAR ALONG PERFORATED LINE



THEN...JOT DOWN THE DOPE ABOUT IT ON THIS FORM. CAREFULLY TEAR IT OUT, FOLD IT AND DROP IT IN THE MAIL.

SOMETHING WRONG WITH THIS PUBLICATION?

FROM: (PRINT YOUR UNIT'S COMPLETE ADDRESS)

DATE SENT

PUBLICATION NUMBER

TM 11-5820-489-10

PUBLICATION DATE

23 Nov 83

PUBLICATION TITLE

Control Group AN/GRA-6

BE EXACT PIN-POINT WHERE IT IS

PAGE NO.	PARA-GRAPH	FIGURE NO.	TABLE NO.

IN THIS SPACE TELL WHAT IS WRONG AND WHAT SHOULD BE DONE ABOUT IT:

TEAR ALONG PERFORATED LINE

PRINTED NAME GRADE OR TITLE AND TELEPHONE NUMBER

SIGN HERE

DA FORM 2028-2
1 JUL 79

PREVIOUS EDITIONS ARE OBSOLETE

P.S.-IF YOUR OUTFIT WANTS TO KNOW ABOUT YOUR RECOMMENDATION MAKE A CARBON COPY OF THIS AND GIVE IT TO YOUR HEADQUARTERS.

FILL IN YOUR
UNIT'S ADDRESS

FOLD BACK

DEPARTMENT OF THE ARMY

OFFICIAL BUSINESS
PENALTY FOR PRIVATE USE \$300

Commander
US Army Communications-Electronics Command
and Fort Monmouth
ATTN: DRSEL-ME-MP
Fort Monmouth, New Jersey 07703

TEAR ALONG PERFORATED LINE

RECOMMENDED CHANGES TO EQUIPMENT TECHNICAL PUBLICATIONS



SOMETHING WRONG WITH THIS PUBLICATION?

THEN...JOT DOWN THE DOPE ABOUT IT ON THIS FORM. CAREFULLY TEAR IT OUT, FOLD IT AND DROP IT IN THE MAIL.

FROM: (PRINT YOUR UNIT'S COMPLETE ADDRESS)

DATE SENT

PUBLICATION NUMBER

TM 11-5820-489-10

PUBLICATION DATE

23 Nov 83

PUBLICATION TITLE

Control Group AN/GRA-6

BE EXACT PIN-POINT WHERE IT IS

PAGE NO.	PARA-GRAPH	FIGURE NO.	TABLE NO.

IN THIS SPACE TELL WHAT IS WRONG AND WHAT SHOULD BE DONE ABOUT IT:

TEAR ALONG PERFORATED LINE

PRINTED NAME GRADE OR TITLE AND TELEPHONE NUMBER

SIGN HERE

DA FORM 2028-2 JUL 79

PREVIOUS EDITIONS ARE OBSOLETE

P.S.--IF YOUR OUTFIT WANTS TO KNOW ABOUT YOUR RECOMMENDATION MAKE A CARBON COPY OF THIS AND GIVE IT TO YOUR HEADQUARTERS.

FILL IN YOUR
UNIT'S ADDRESS

FOLD BACK

DEPARTMENT OF THE ARMY

OFFICIAL BUSINESS
PENALTY FOR PRIVATE USE \$300

Commander
US Army Communications-Electronics Command
and Fort Monmouth
ATTN: DRSEL-ME-MP
Fort Monmouth, New Jersey 07703

TEAR ALONG PERFORATED LINE

By Order of the Secretaries of the Army and the Air Force:

JOHN A. WICKHAM JR.
General, United States Army
Chief of Staff

Official:

ROBERT M. JOYCE
Major General, United States Army
The Adjutant General

Official:

JAMES P. MULLINS
General, USAF, Commander, Air Force
Logistics Command

CHARLES A. GABRIEL
General, USAF
Chief of Staff

DISTRIBUTION:

To be distributed in accordance with DA Form 12-51, Operator's Maintenance requirements for AN/GRA-6.

PIN: 052662-000